

ASSEMBLY INSTRUCTIONS
INSTRUCCIONES DE MONTAJE
NOTICE DE MONTAGE

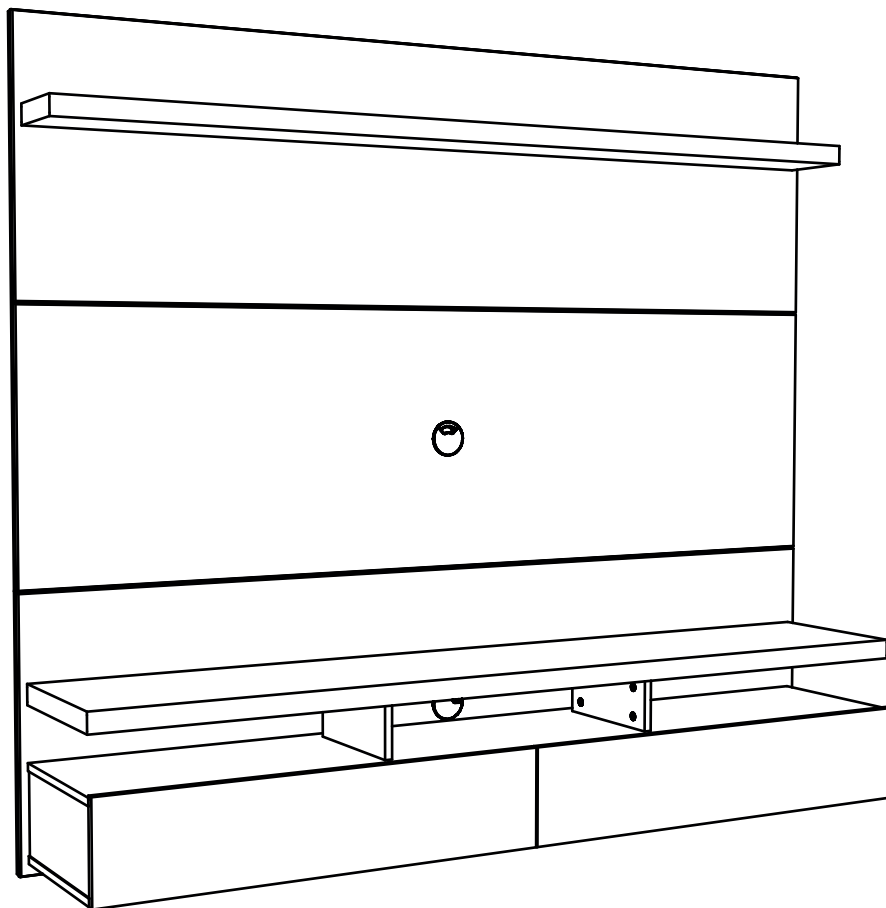

COD:28800

REV. 10 - 01/03/23

STICKER - 16X
ADHESIVO - 16X
AUTOCOLLANT - 16X

COD. 4462-4x

COD. 1668-25x
6.0 X 30

COD. 9070-6x

COD. 4157-9x

COD. 2511-4x

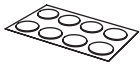

A

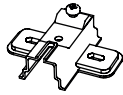

B



C

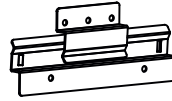

D

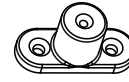

E

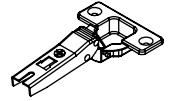

F

WIRE CHANNEL - 2X
PASAJE DE ALAMBRE - 2X
PASSE-CÂBLES - 2X

COD. 0348-1x

COD. 2088-16x
UX8

COD. 10063-12x

COD. 0599-12x



G



H



I



J



K

COD. 0160-18x
4.0 X 12

COD. 3557-18x
4.0 X 14

COD. 3706-18x
4.0 X 30

COD. 3527-20x
4.0 X 45

COD. 4762-13x
4.0 X 50



L

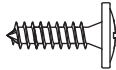

M



N

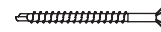

O

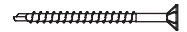

P

COD. 7519-16x
4.5 X 16

COD. 6244-12x
6.0 X 65

COD. 4505-4x
6.0 X 100

SUPORT TV - 1x
APOYO DE TV - 1x
SUPPORT MURAL POUR TV - 1x



Q



R



S

T

Hazard Warning: This unit has only been tested to be mounted on brick and concrete walls. For drywall, please use extra toggle bolts, however, we are not liable for any mounting or falling issues. The unit must be mounted on brick and concrete for extra security.

Advertencia de peligro: esta unidad solo ha sido probada para montarse en paredes de ladrillo y hormigón. Para paneles de yeso, use pernos de palanca adicionales; sin embargo, no nos hacemos responsables de ningún problema de montaje o caída. La unidad debe montarse sobre ladrillo y hormigón para mayor seguridad.



Avertissement de danger: cette unité a été testée uniquement pour être montée sur des murs en brique et en béton. Pour les cloisons sèches, veuillez utiliser des boulons à ailettes supplémentaires, cependant, nous ne sommes pas responsables des problèmes de montage ou de chute. L'unité doit être montée sur de la brique et du béton pour plus de sécurité.



Use the PVA glue before screwing.

Use pegamento PVA antes de atornillar.

Utilisez de la colle PVA avant de visser.

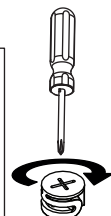
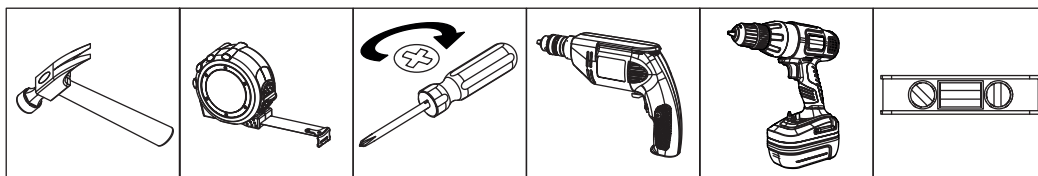

DESCRIPTION

DESCRIPCIÓN

DESCRIPTION

W:62.99 inches H:63.43 inches D: 15.27 inches
 L:1600mm A:1611mm P:388 mm
 L:1600mm H:1611mm P:388 mm

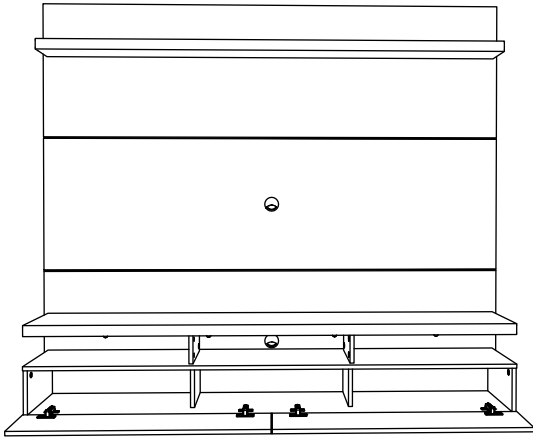

CÓD:28800					
PART PIEZA PIÈCE	QUANTITY CANTIDAD QUANTITÉ	DESCRIPTION	DESCRIPCIÓN	DESCRIPTION	BOX CAJA BOÎTE
03	01	TOP SHELF	ESTANTE	ÉTAGÈRE	01
10	01	TOP PANEL	PANEL SUPERIOR	PANNEAU SUPÉRIEUR	01
11	01	WIRE CHANNEL PANEL	PANEL PASAJE DE ALAMBRE	PANNEAU DOTÉ DE PASSE-CÂBLES	01
13	02	SIDE BATTEN	SOPORTE LATERAL	LATTE LATÉRALE	01
22	01	TOP BOARD	CUBIERTA SUPERIOR	PLATEAU SUPÉRIEUR	02
23	01	CENTER BOARD	CUBIERTA CENTRAL	PLATEAU CENTRALE	02
24	01	BOTTOM BOARD	CUBIERTA INFERIOR	PLATEAU INFÉRIEUR	02
25	02	UPPER DIVIDER	DIVISION SUPERIOR	DIVISEUR SUPÉRIEUR	01
26	02	BOTTOM DIVIDER	DIVISION INFERIOR	DIVISEUR INFÉRIEUR	01
27	01	LEFT SIDE	LATERAL IZQUIERDA	CÔTÉ GAUCHE	01
28	01	RIGHT SIDE	LATERAL SUPERIOR	CÔTÉ DROIT	01
32	02	DOOR	PUERTA	PORTE	01
33	01	BACK PANEL	PANEL TRASERO	PANNEAU ARRIÈRE	01
34	02	BATTEN	SOPORTE	LATTES	01

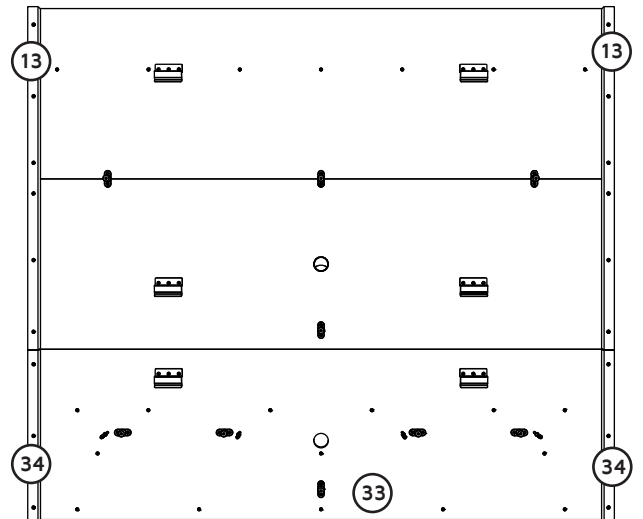
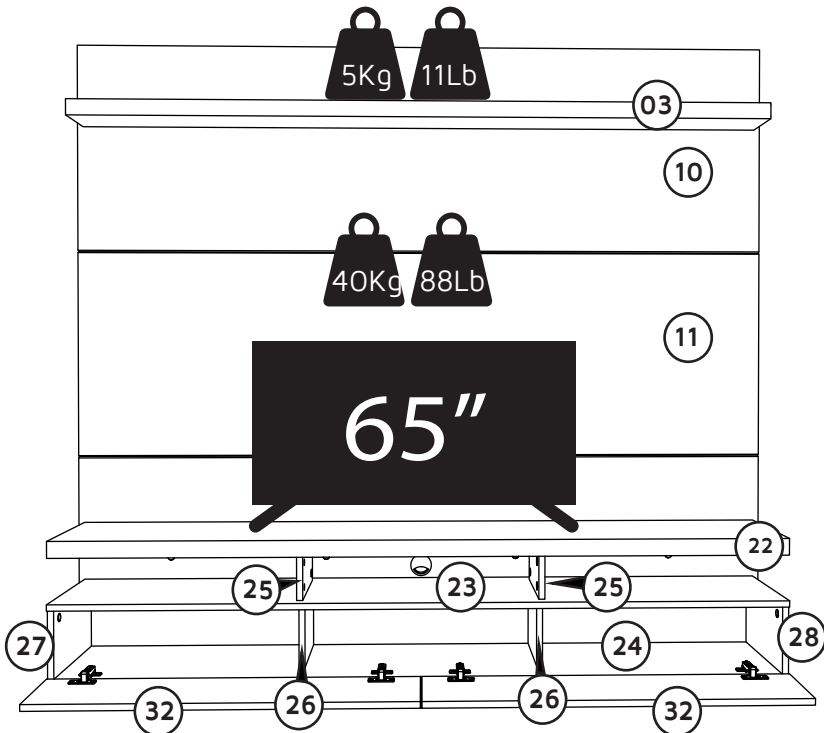

STICKER A	COD. 4462 B	COD. 1668 C	COD. 10063 J	COD. 0599 K	COD. 3527 O	COD. 4762 P	COD. 7519 Q
--------------	----------------	----------------	-----------------	----------------	----------------	----------------	----------------

01

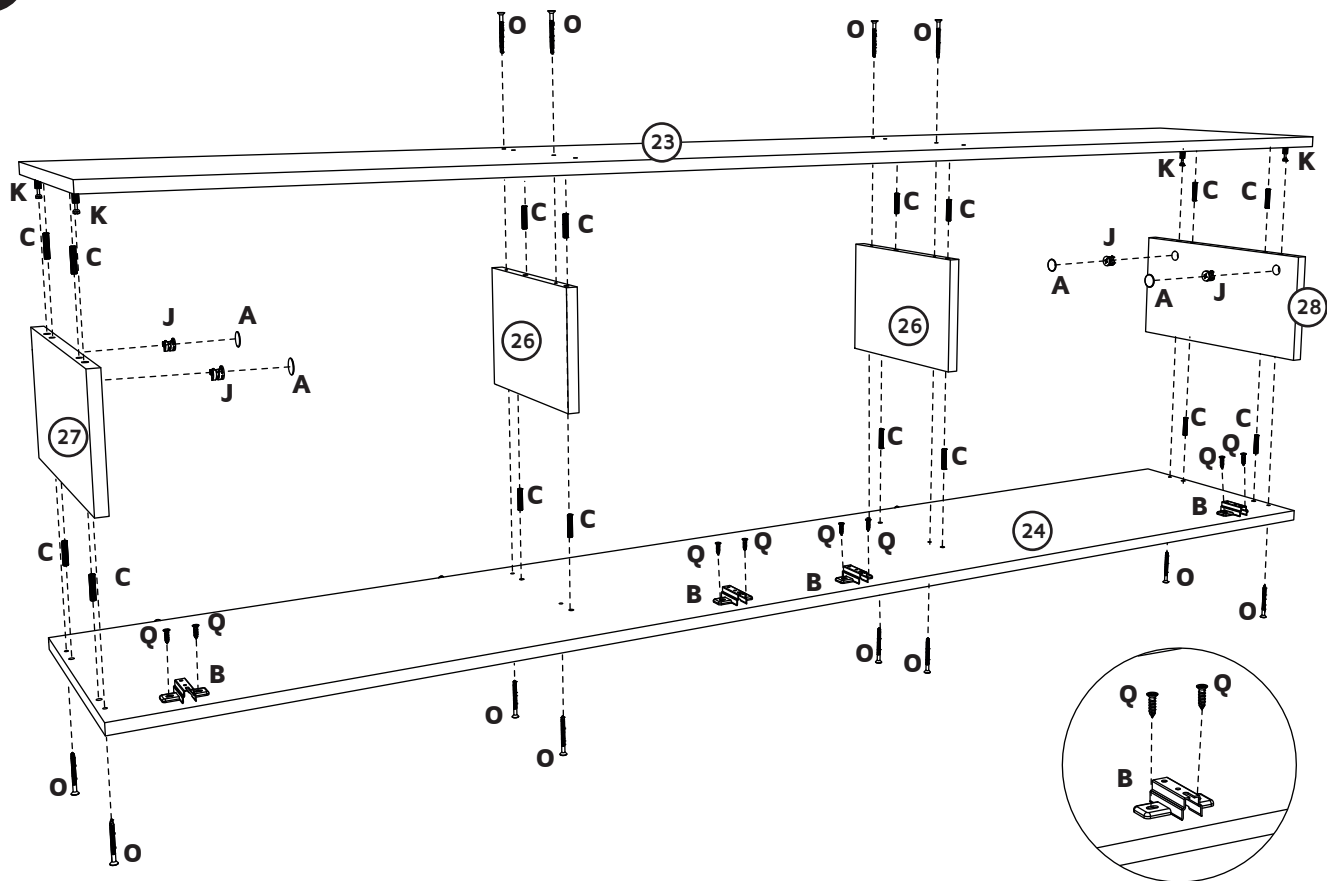



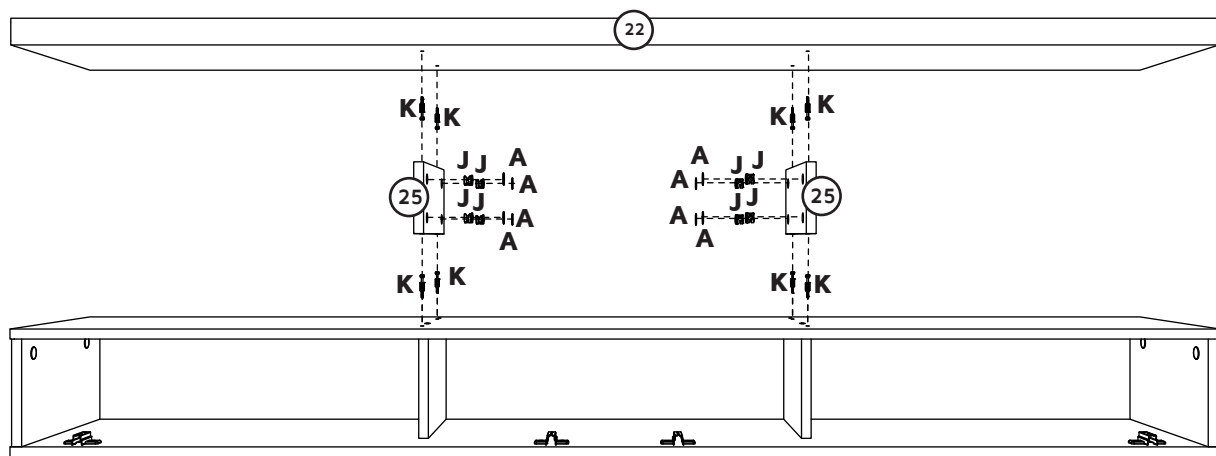



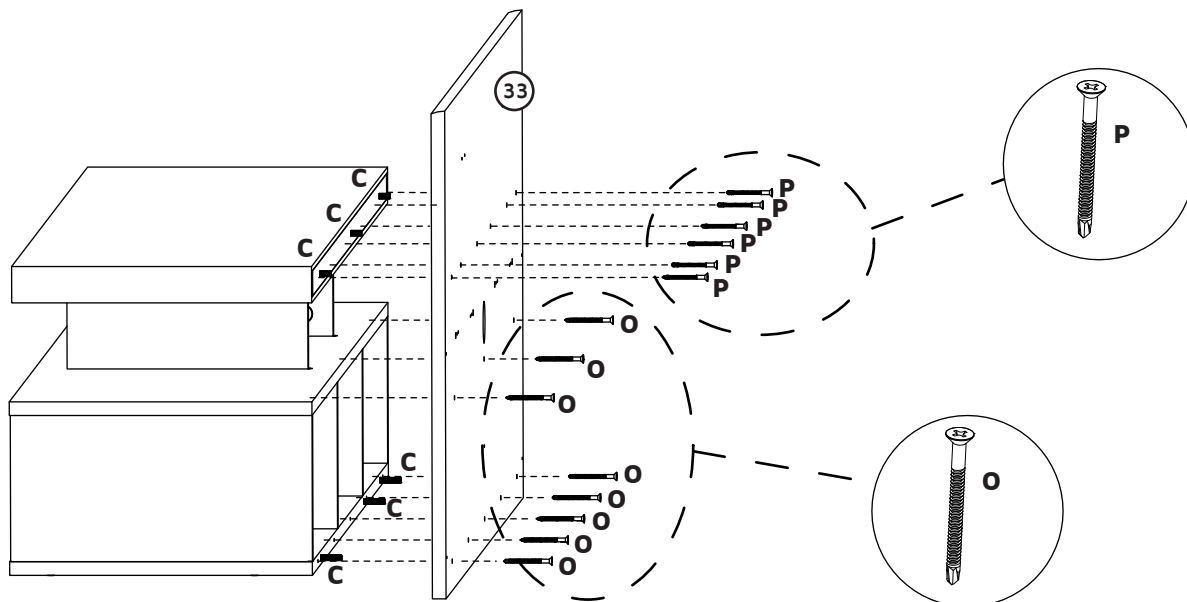

02



03



COD. 1668 C 	COD. 9070 D 	COD. 4157 E 	COD. 0348 H 	COD. 0160 L 	COD. 3557 M 	COD. 3706 N 	COD. 4762 P 
---	---	---	---	--	---	---	---

04

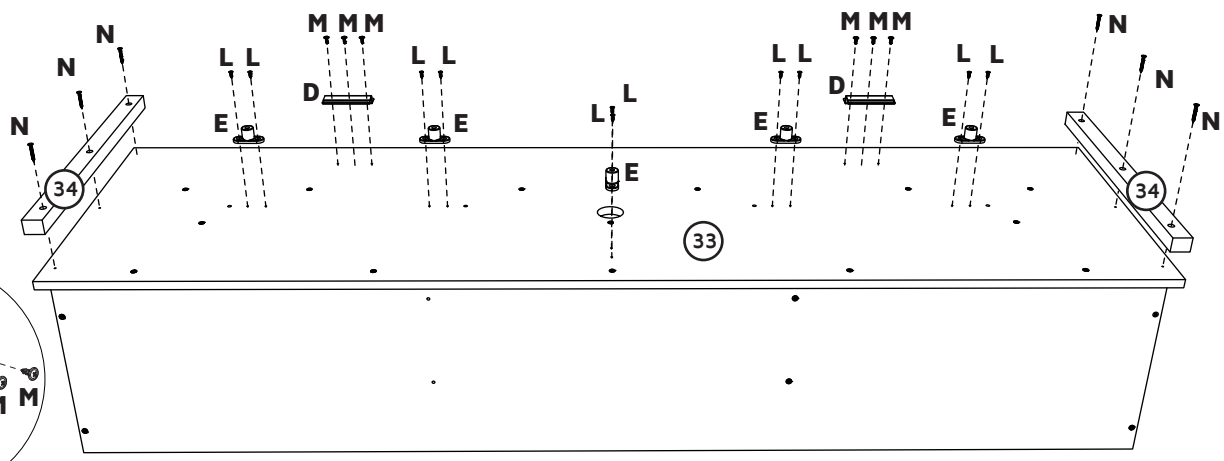
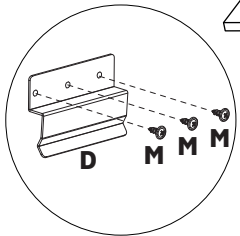
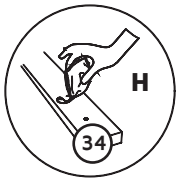

05

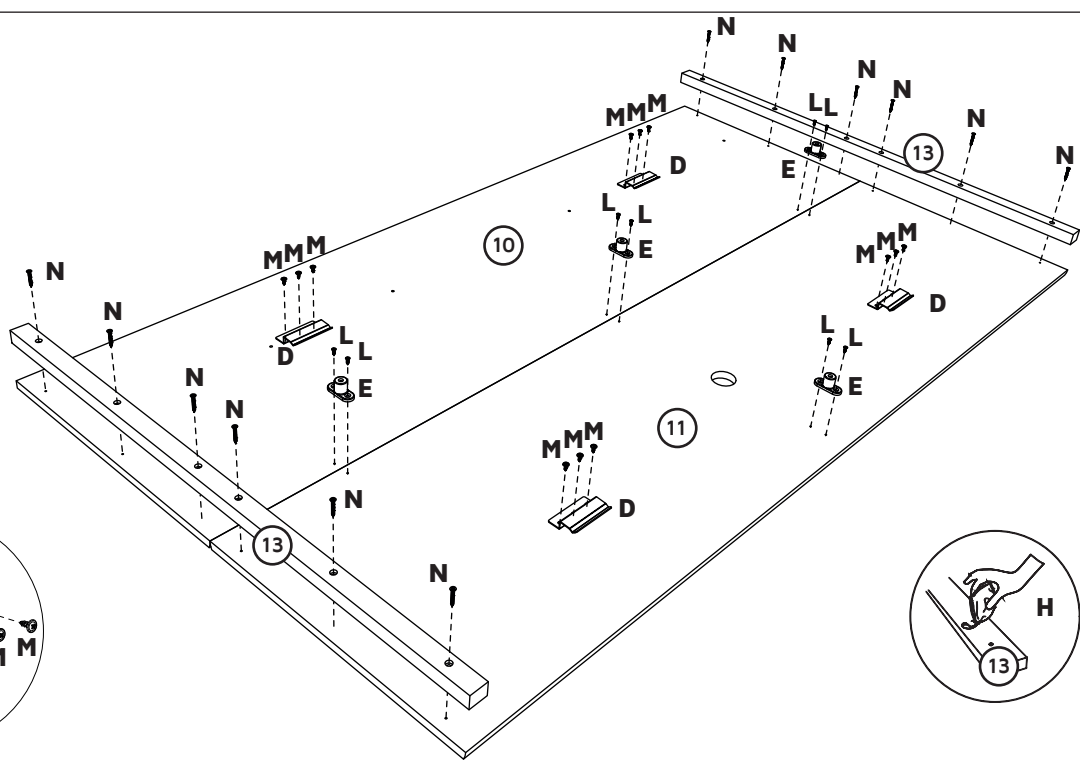
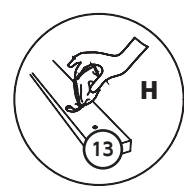
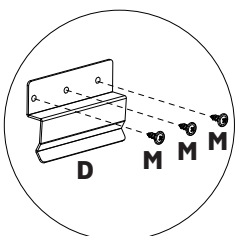

06

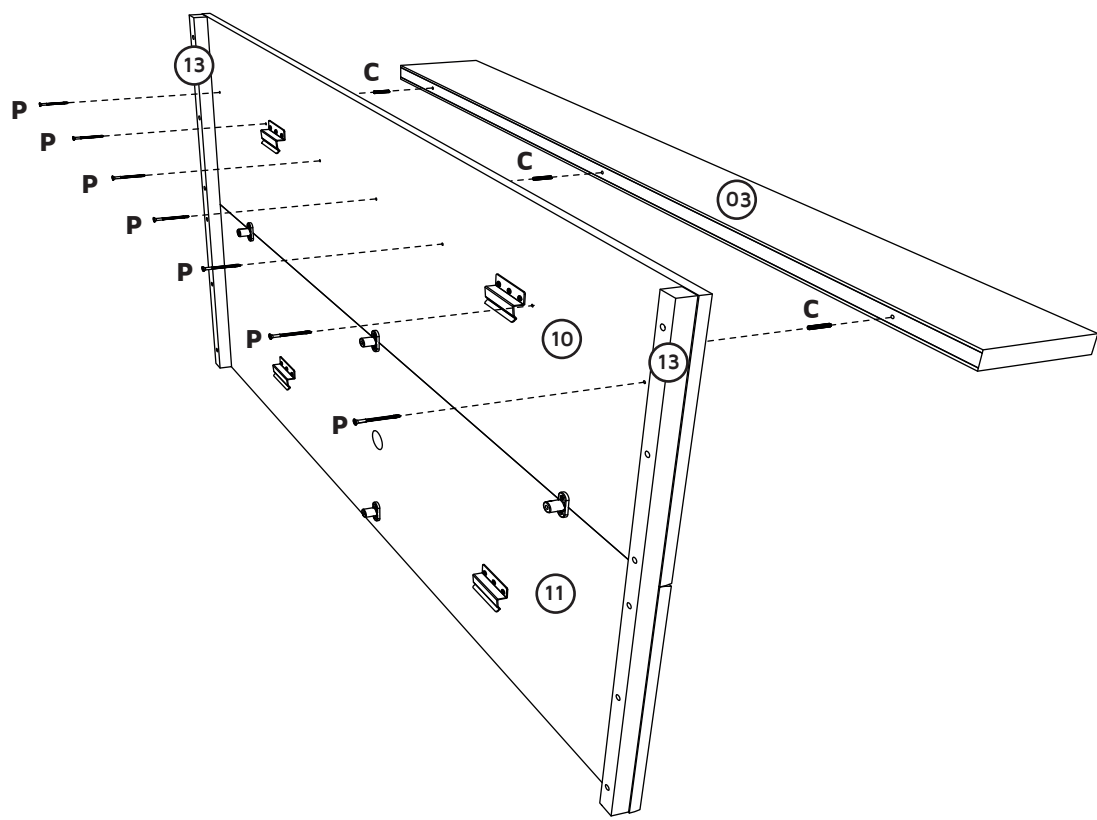



4°
3°
2°
1°

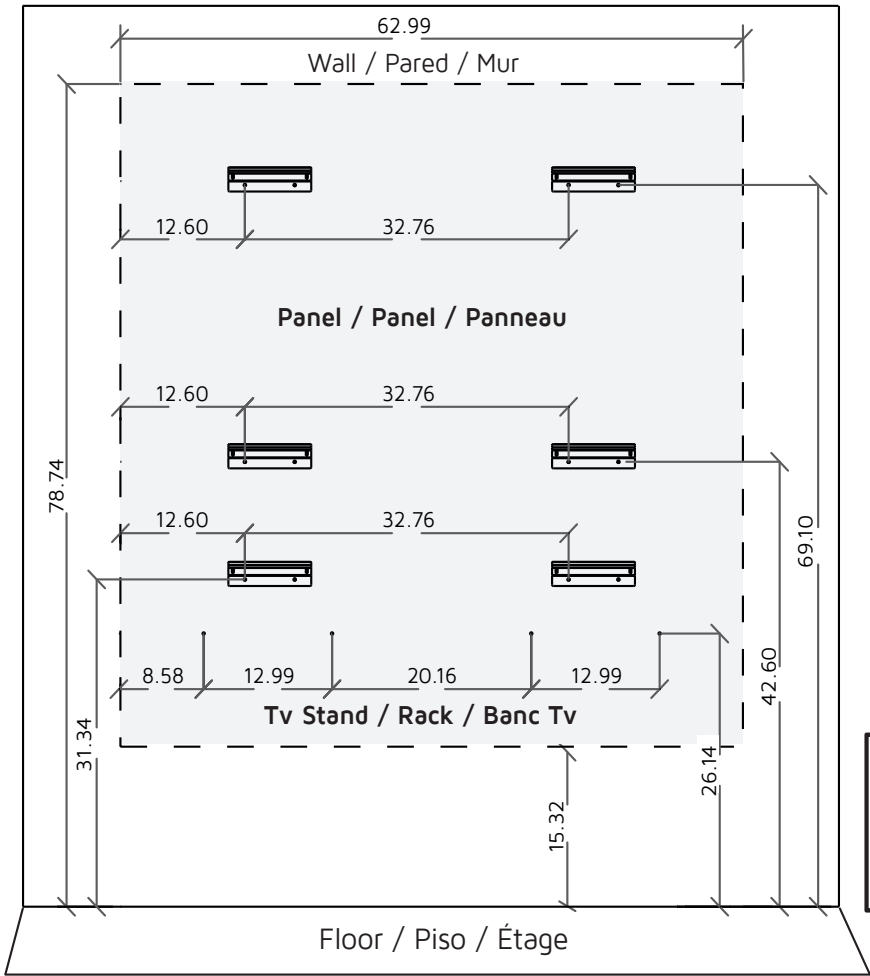

Measurement to drill the wall. (em inches).

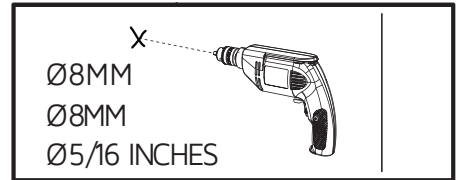
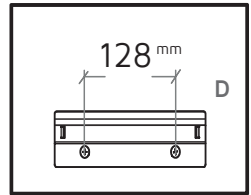
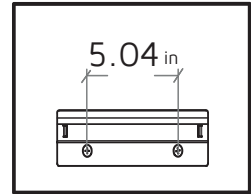

4°
3°
2°
1°

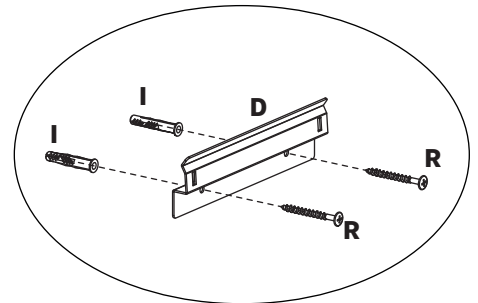
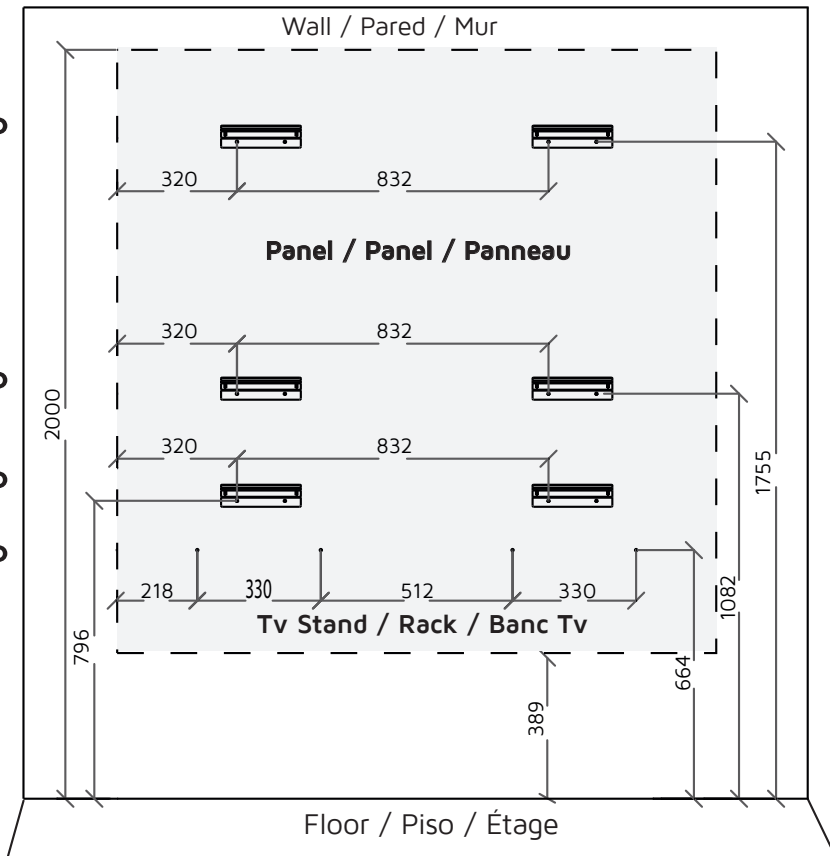

Medidas para realizar la perforación de la pared (en milímetros).

Mesures pour percer le mur (en millimètres).



08

Attention
Atención
Attention

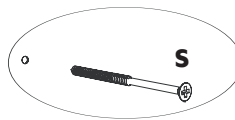
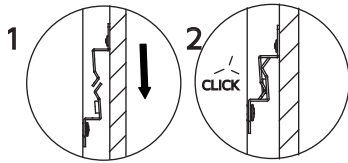
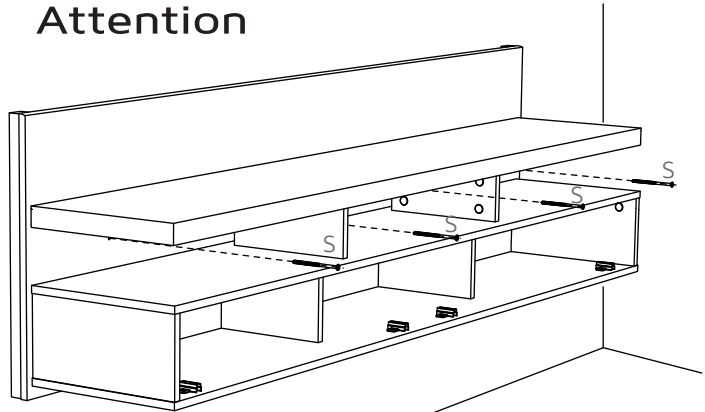
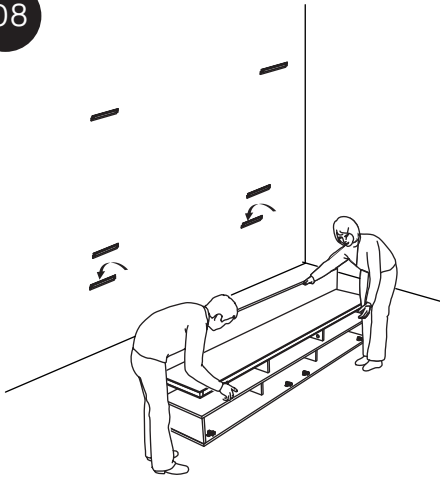

SAFETY SCREW
TORNILLO DE SEGURIDAD
VIS DE SÉCURITÉ



Pass the cables through the wire channel before screwing (S)
Lleve el cables antes atornillar (S).
Acheminez les câbles avant de visser (S).

09

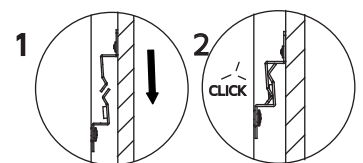
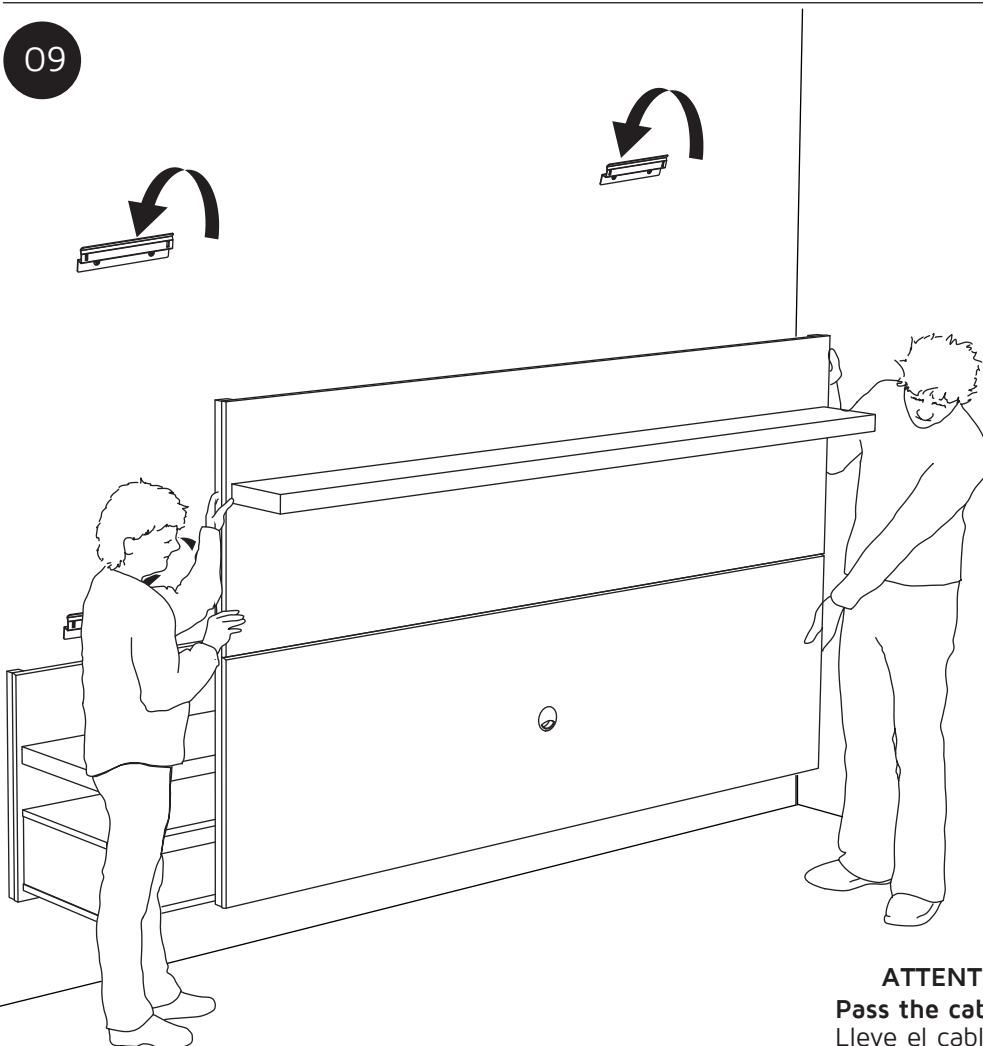

ATTENTION / ATENCIÓN / ATTENTION
Pass the cables through the back before Panel.
Lleve el cables antes de encajar el panel.
Acheminez les câbles avant de fixer le panneau.

STICKER ADHESIVO AUTOCOLLANT A	WIRE CHANNEL PASA EL CABLE PASSE-CABLES G	COD. 2511 F	COD. 7519 Q
--	---	-----------------------	-----------------------

