

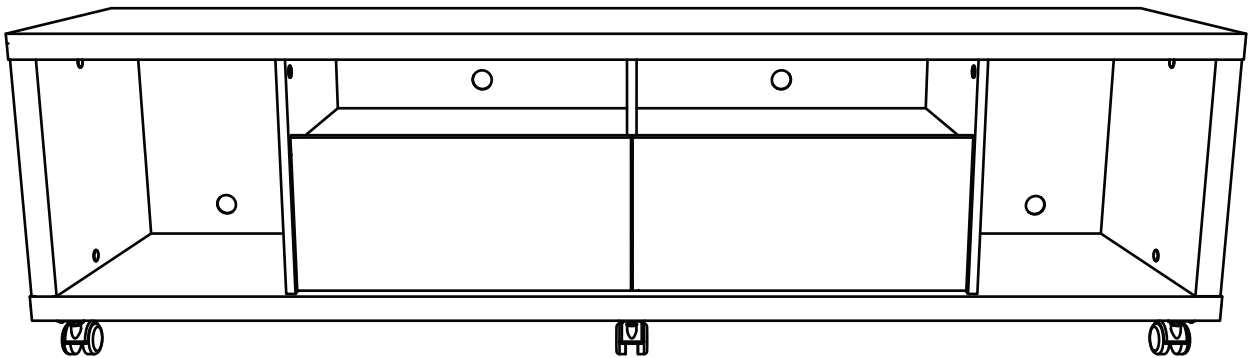

MANHATTAN
COMFORT

ASSEMBLY INSTRUCTIONS



COD: 15400

REV. 00

IMPORTANT REMARKS



Never climb or lean on the furniture. You may suffer serious accidents.

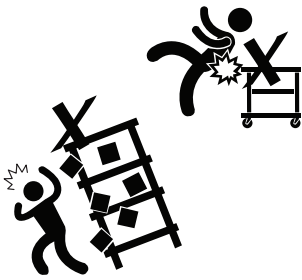

Use the packaging to cover the assembly area and separate all parts.

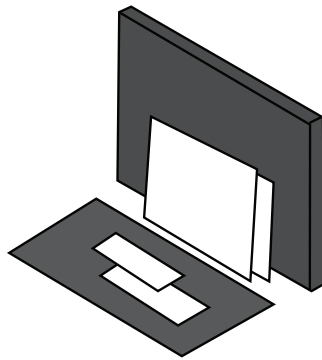

Identify the parts by observing the number printed on their edges.

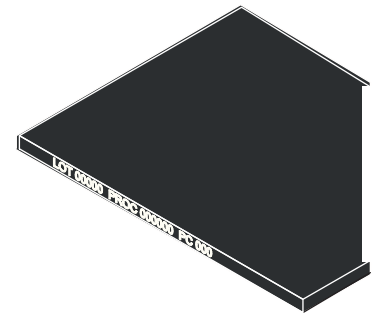

CARE INSTRUCTIONS



Wipe clean using a damp cloth and a mild cleaner. Do not use abrasive and chemical products.



HANDLING

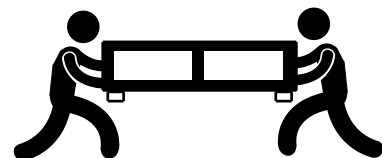

Move the piece carefully, don't drag it. Ask for someone else's help to do so.

HARDWARE



Identify and separate the hardware used in the assembly. There's a label on each package identifying the parts and where to use them.

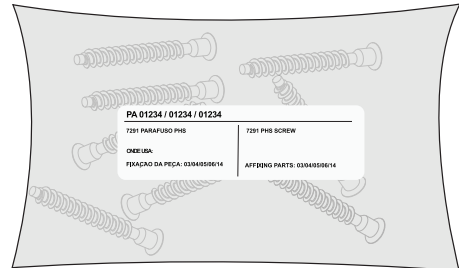

cod.1533-12x



A

cod.0329-26x



B

cod.2661-2x



C

cod.3527-11x

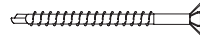

D

cod.0342-14x



E

cod.6533-8x

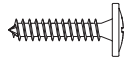

F

cod.0599-9x



G

cod.0494-9x



H

STICKER-6x

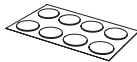

I

cod.1861-24x

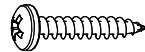

J

cod.1668-16x



K

cod.9058-4x



L

cod.0338-4x



M

cod.7531-2x



N

cod.0357

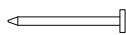

O

cod.3283-5x

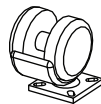

P

cod.3284-1x

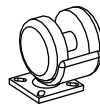

Q

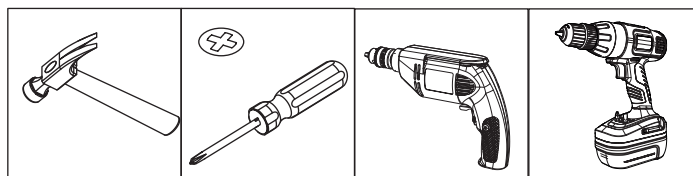





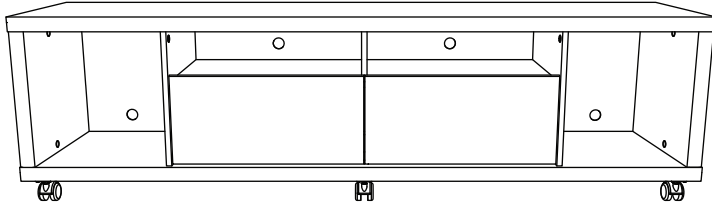



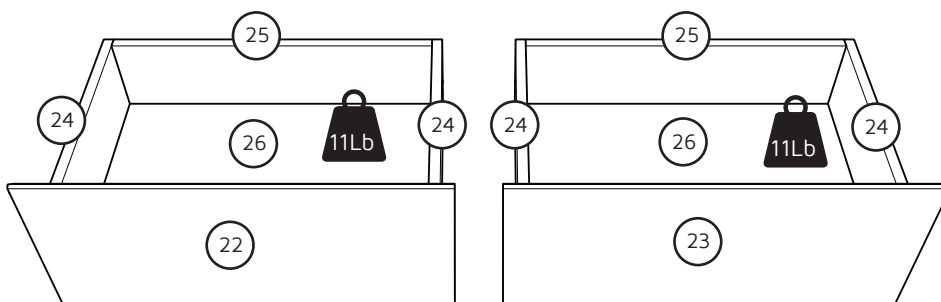
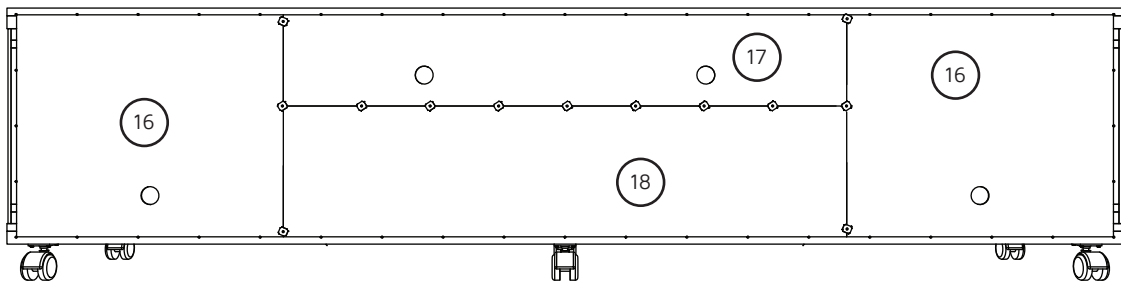
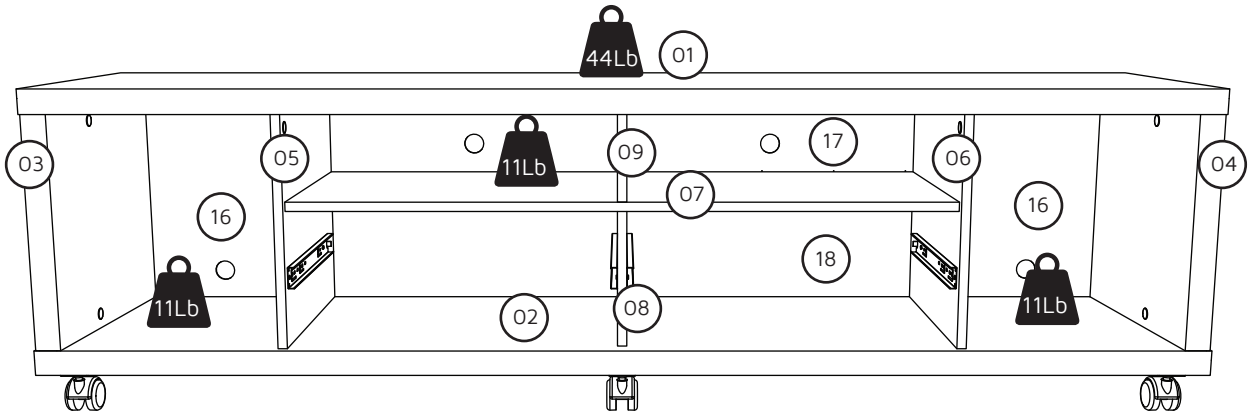

DESCRIPTION

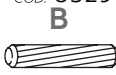
W:71,06 inches H:20,86 inches D:17,59 inches
L:1805mm A:530mm P:447mm

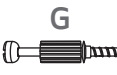

CÓD:15400			
PART	QUANTITY	DESCRIPTION	BOX
01	01	TOP BOARD	01
02	01	BASE	01
03	01	LEFT SIDE	02
04	01	RIGHT SIDE	02
05	01	LEFT INNER SIDE	02
06	01	RIGHT INNER SIDE	02
07	01	CENTER SHELF	02
08	01	LOWER DIVISION	02
09	01	UPPER DIVISION	02
16	03	SIDE BACKPLATE	01
17	06	UPPER BACKPLATE	01
18	06	LOWER BACKPLATE	01
22	01	LEFT DRAWER FRONT	02
23	01	RIGHT DRAWER FRONT	02
24	02	DRAWER SIDE	02
25	02	DRAWER BACK PANEL	02
26	02	DRAWER BOTTOM	02



COD. 1533 A 	COD. 0329 B 	COD. 2661 C 	COD. 0599 G 	COD. 0494 H 	COD. 1861 J 	COD. 9058 L 	COD. 7531 N 	COD. 3283 P 	COD. 3284 Q 
-----------------------------------------------------------------------------------------------------------	-----------------------------------------------------------------------------------------------------------	-----------------------------------------------------------------------------------------------------------	-----------------------------------------------------------------------------------------------------------	-----------------------------------------------------------------------------------------------------------	-----------------------------------------------------------------------------------------------------------	-------------------------------------------------------------------------------------------------------------	-------------------------------------------------------------------------------------------------------------	-------------------------------------------------------------------------------------------------------------	-------------------------------------------------------------------------------------------------------------



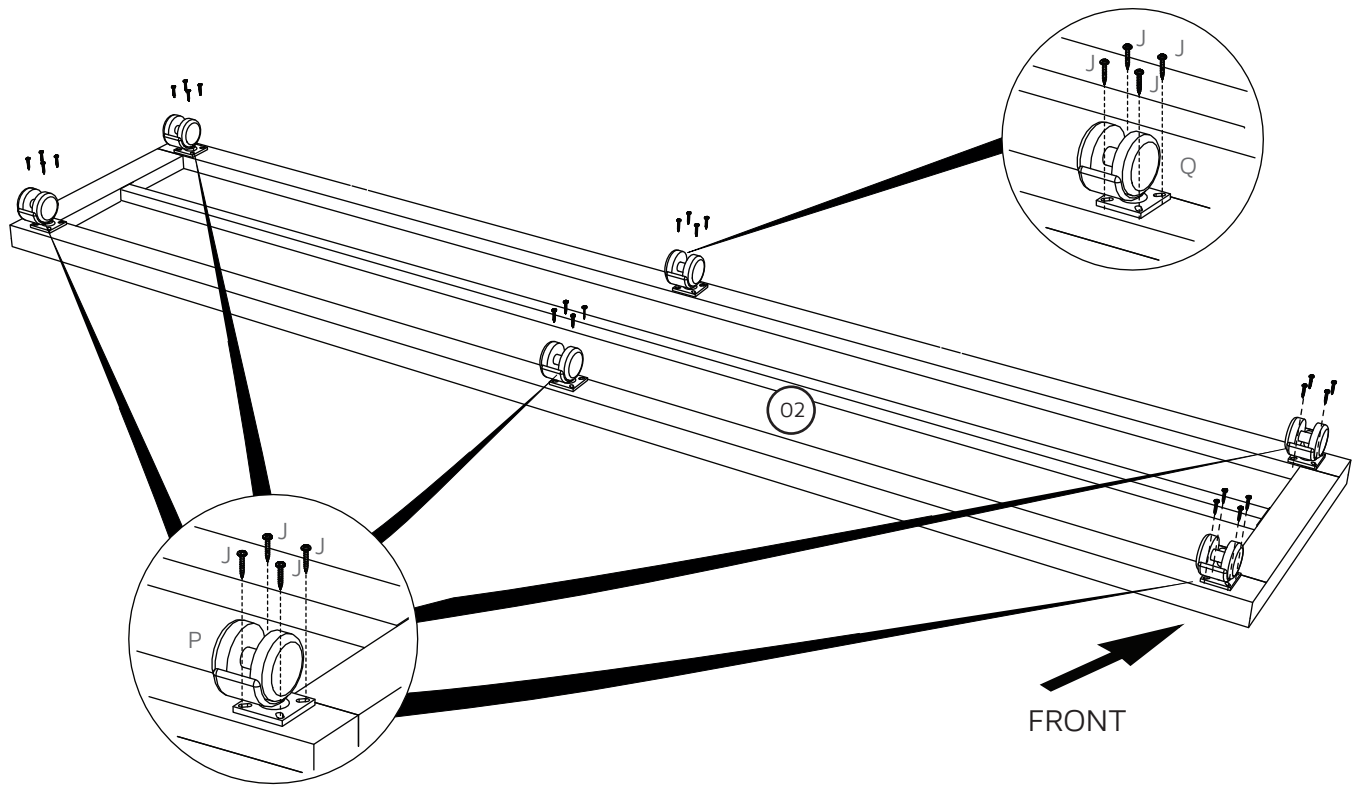

01

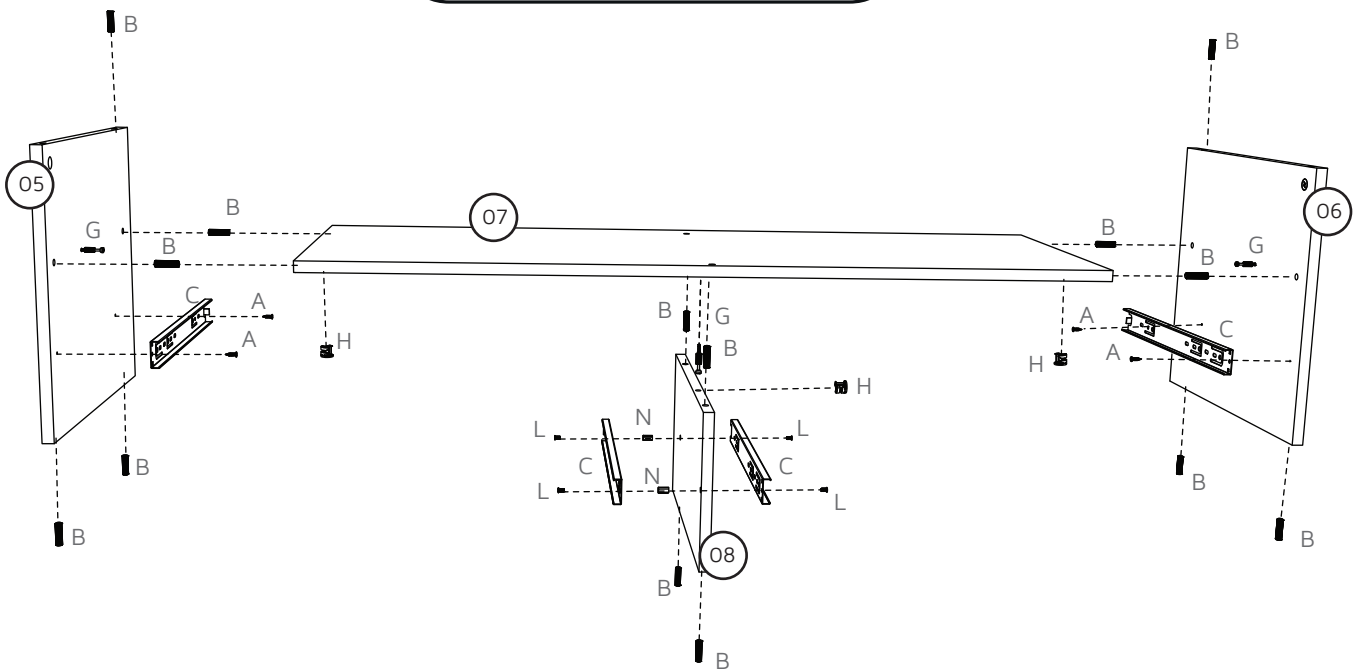
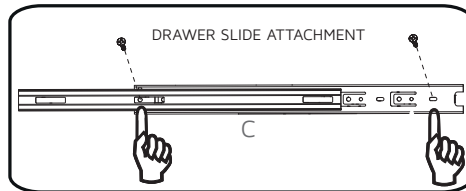

02

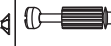

03



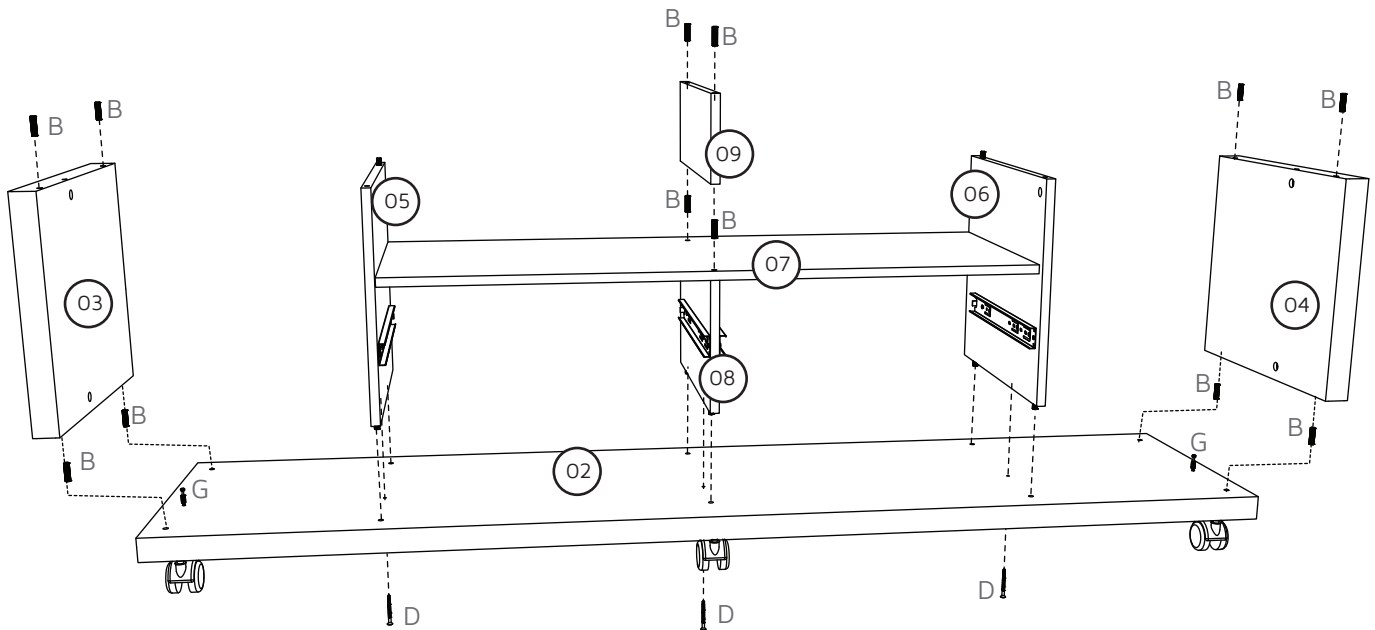

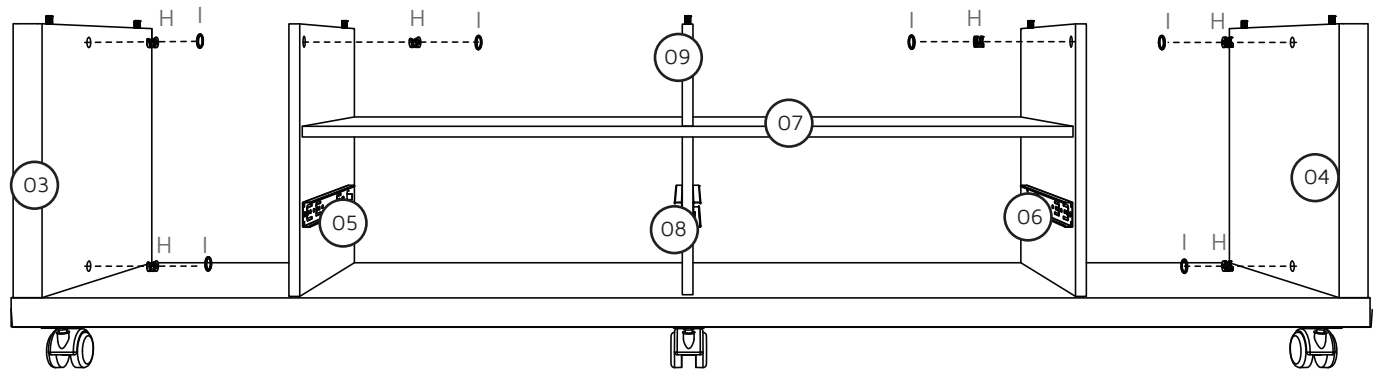
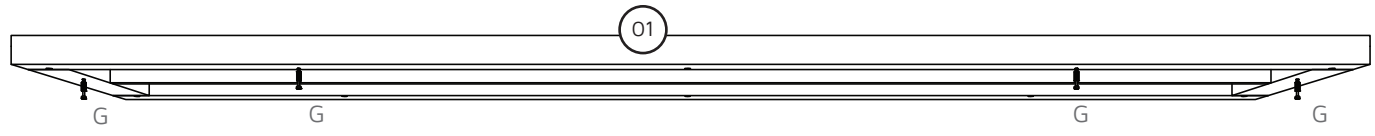
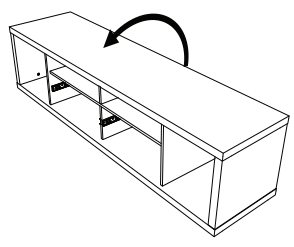

cod. 0329 B 	cod. 0329 D 	cod. 0599 G 	cod. 0494 H 	I 
-----------------------------------------------------------------------------------------------------------	------------------------------------------------------------------------------------------------------------	-------------------------------------------------------------------------------------------------------------	-------------------------------------------------------------------------------------------------------------	------------------------------------------------------------------------------------------------



04



05

cod. 1533 A 	cod. 2661 C 	cod. 3527 D 	cod. 1668 E 	cod. 1668 K 	cod. 0338 M 	cod. 0357 O 
-----------------------------------------------------------------------------------------------------------	-----------------------------------------------------------------------------------------------------------	-----------------------------------------------------------------------------------------------------------	-------------------------------------------------------------------------------------------------------------	-------------------------------------------------------------------------------------------------------------	-------------------------------------------------------------------------------------------------------------	-------------------------------------------------------------------------------------------------------------

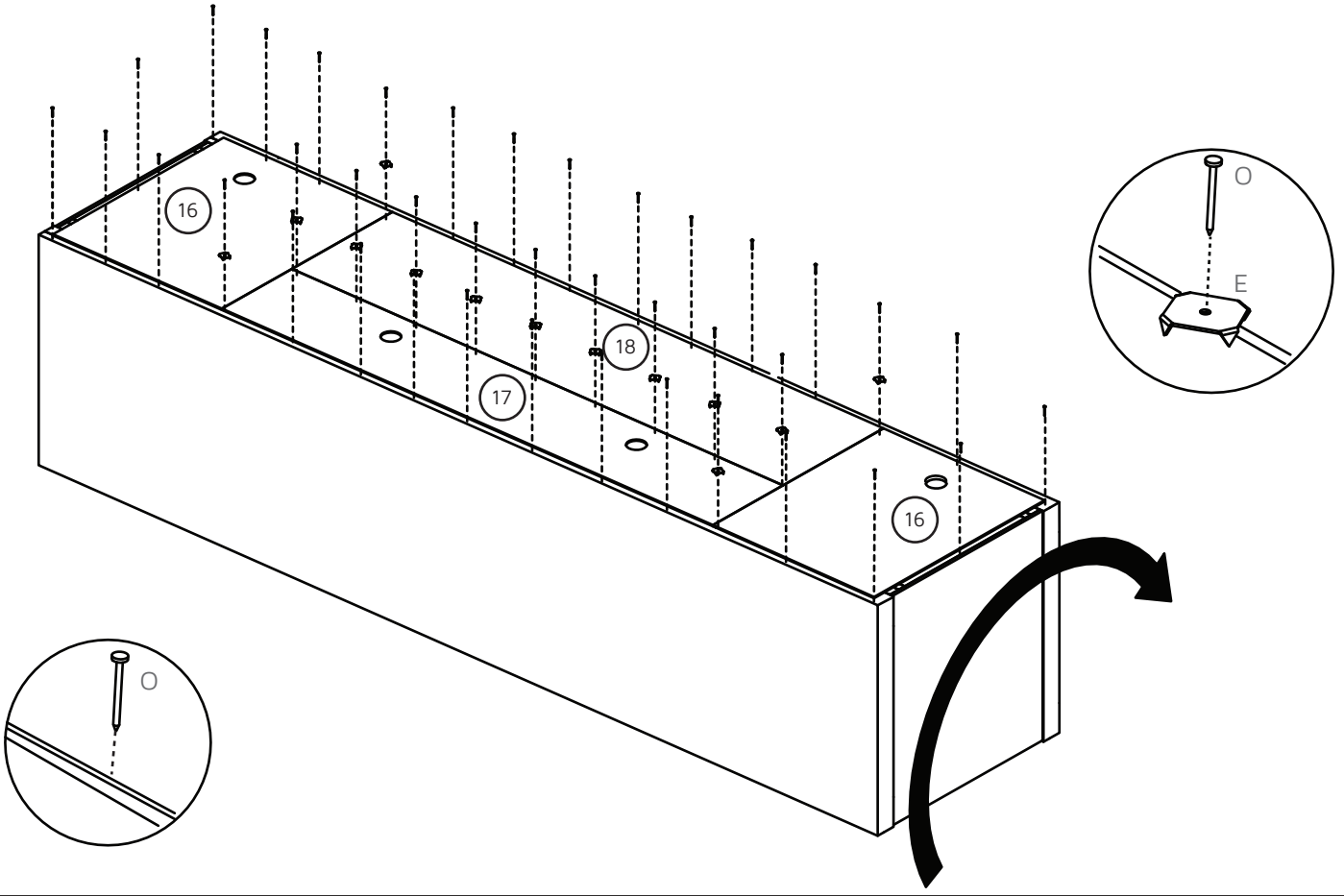

06

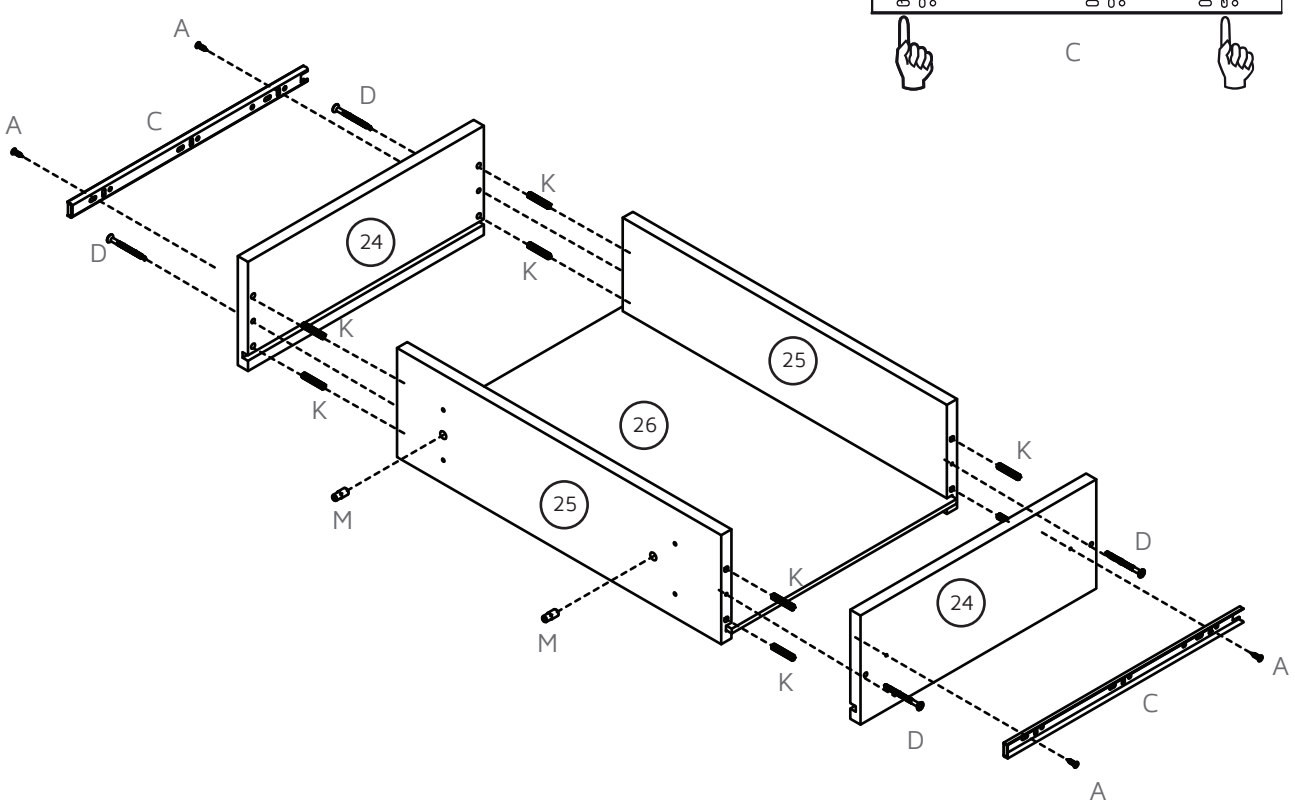
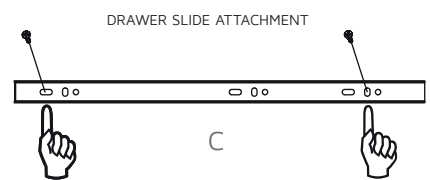

07

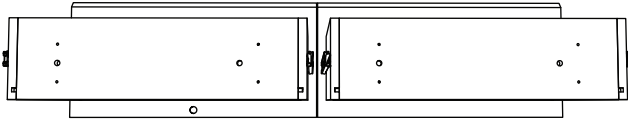
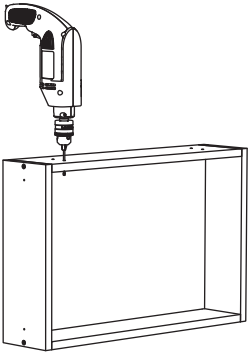

RIGHT

LEFT

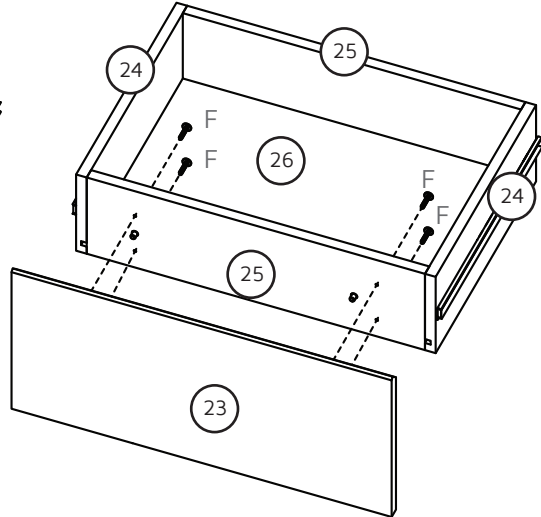
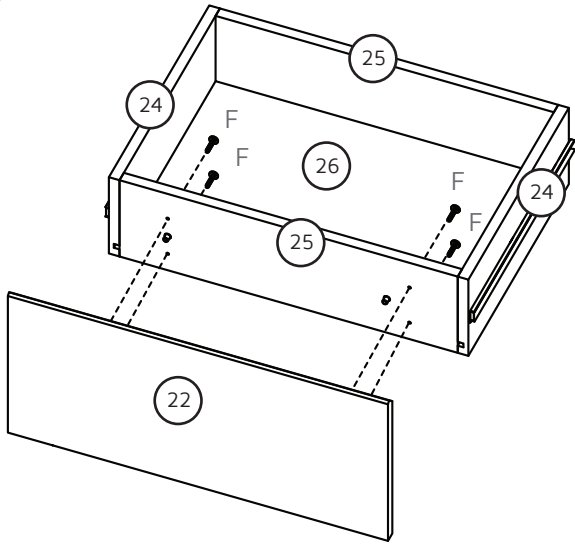

08

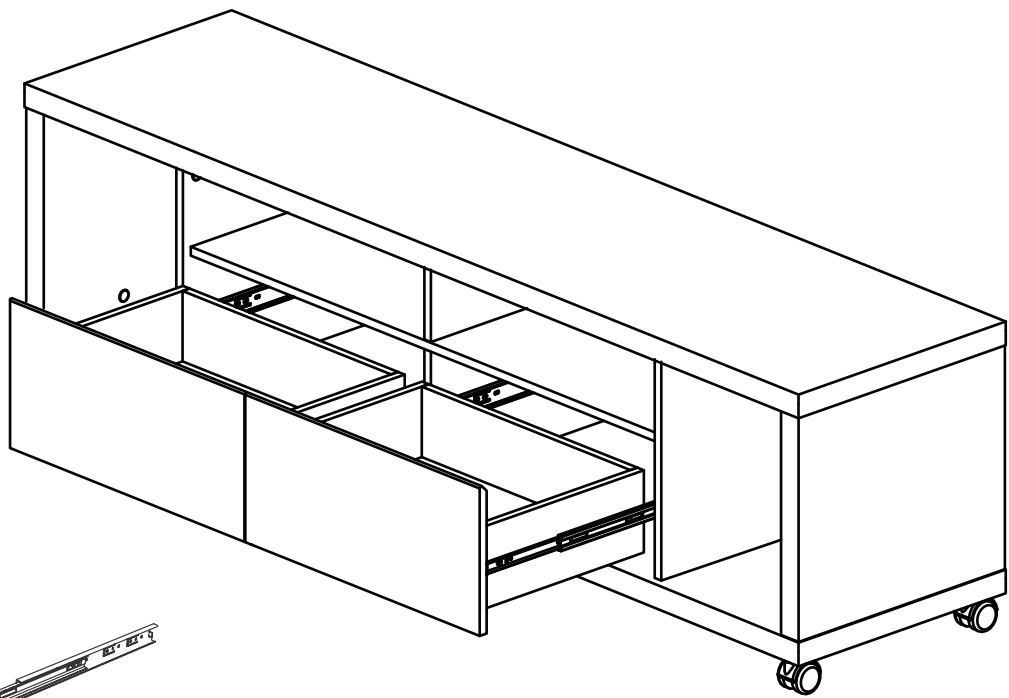

DETAIL

