

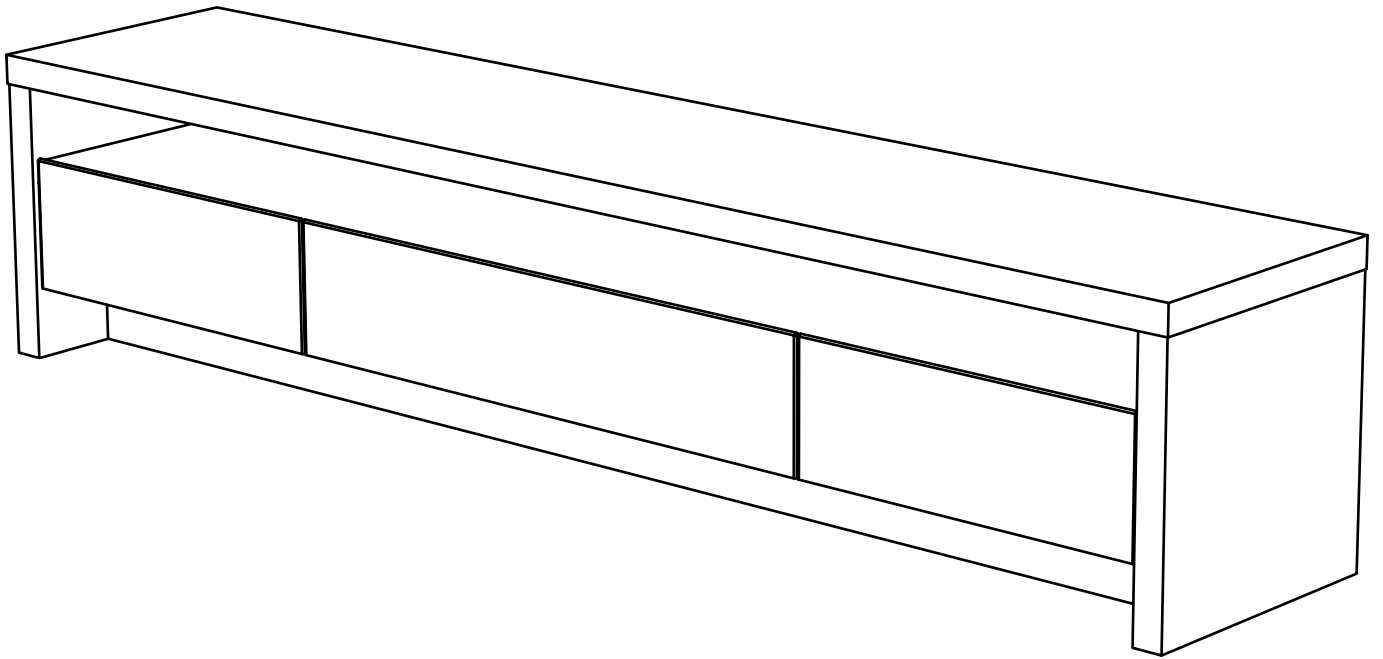

MANHATTAN
COMFORT

ASSEMBLY INSTRUCTIONS



COD: 221200

REV. 02

IMPORTANT REMARKS



Never climb or lean on the furniture. You may suffer serious accidents.

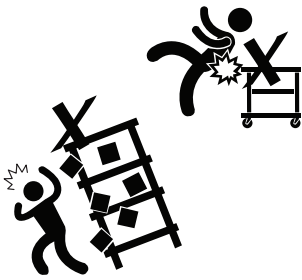

Use the packaging to cover the assembly area and separate all parts.

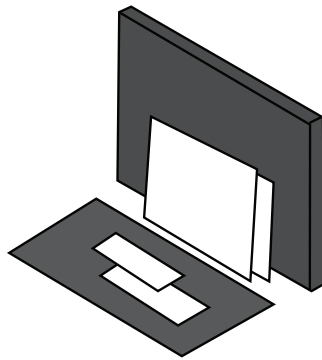

Identify the parts by observing the number printed on their edges.

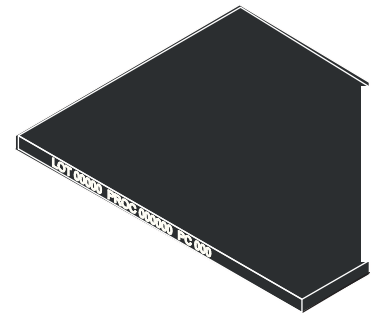

CARE INSTRUCTIONS



Wipe clean using a damp cloth and a mild cleaner. Do not use abrasive and chemical products.



HANDLING

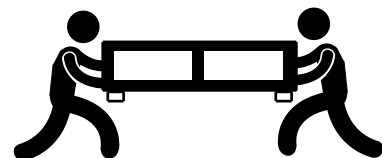

Move the piece carefully, don't drag it. Ask for someone else's help to do so.

HARDWARE



Identify and separate the hardware used in the assembly. There's a label on each package identifying the parts and where to use them.

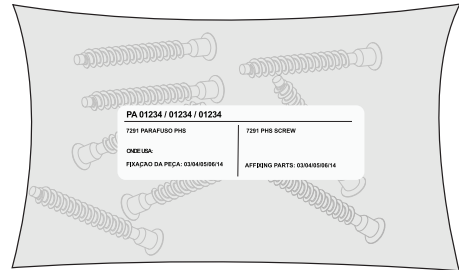

COD. 1533-48x



A

COD. 5798-4x



B

COD. 2661-3x



C

COD. 3527-14x

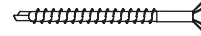

D

COD. 8056-4x

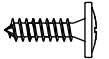

E

COD. 6533-12x



F

COD. 9895-14x

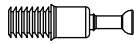

G

COD. 10063-14x



H

STICKER-4X

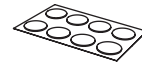

I

COD. 10342-4x



J

COD. 1668-50x



K

COD. 7313-2x



L

COD. 0338-6x



M

COD. 0136-8x



N

COD. 0357-40x



O

COD. 10499-2x

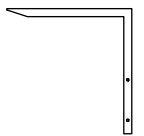

P

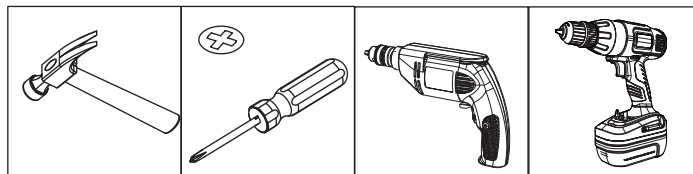





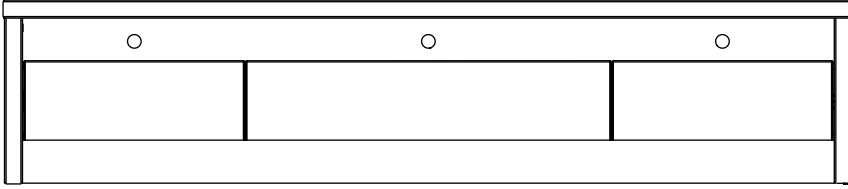

DESCRIPTION

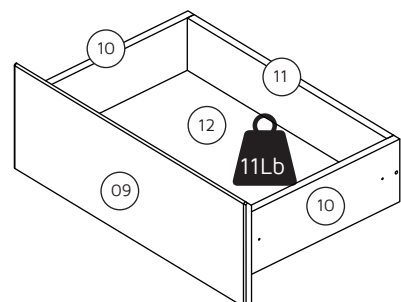
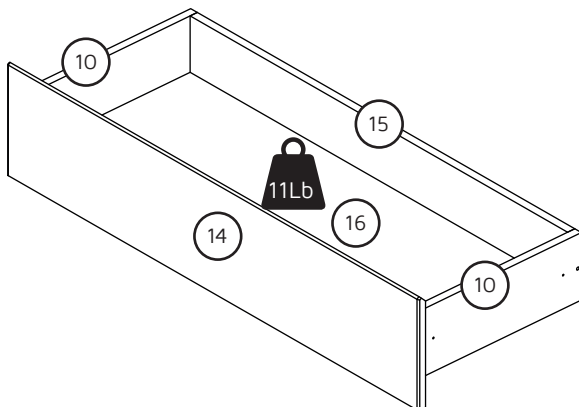
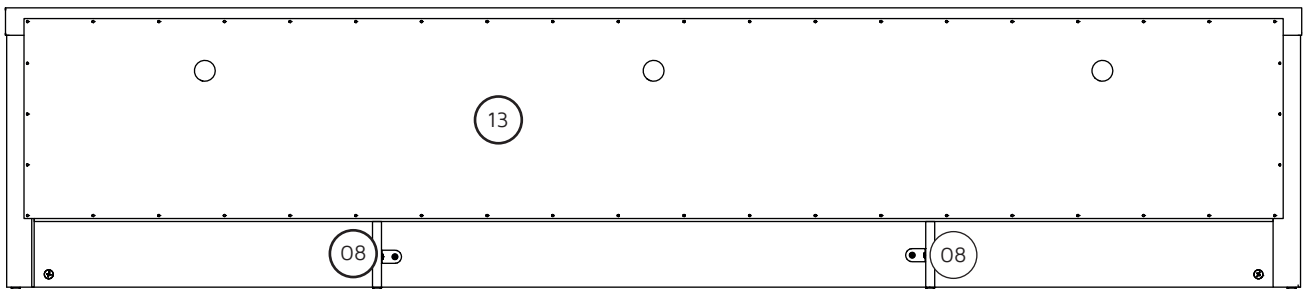
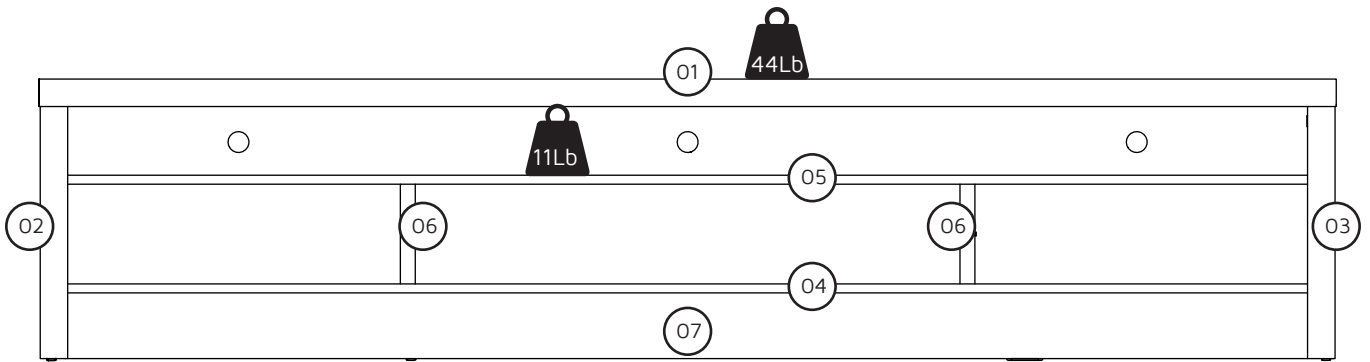
W:85,70 inches H:18,42 inches D:17,32 inches
L:2177mm A:468mm P:440mm



CÓD:221200			
PART	QUANTITY	DESCRIPTION	BOX
01	01	TOP PANEL	01
02	01	LEFT SIDE	02
03	01	RIGHT SIDE	02
04	01	BASE	02
05	01	SHELF	02
06	02	DIVIDER	02
07	01	BATTEN	01
08	02	SUPPORT	01
09	02	DRAWER FRONT	01
10	06	DRAWER SIDE	02
11	04	DRAWER BACK PANEL	02
12	02	DRAWER BOTTOM	01
13	01	BACKPLATE	01
14	01	DRAWER FRONT	01
15	02	DRAWER BACK PANEL	02
16	01	DRAWER BOTTOM	01



COD. 5798 B 	COD. 3527 D 	COD. 9895 G 	COD. 10063 H 	COD. 1668 K 	COD. 7313 L 
---	---	--	--	---	---

01

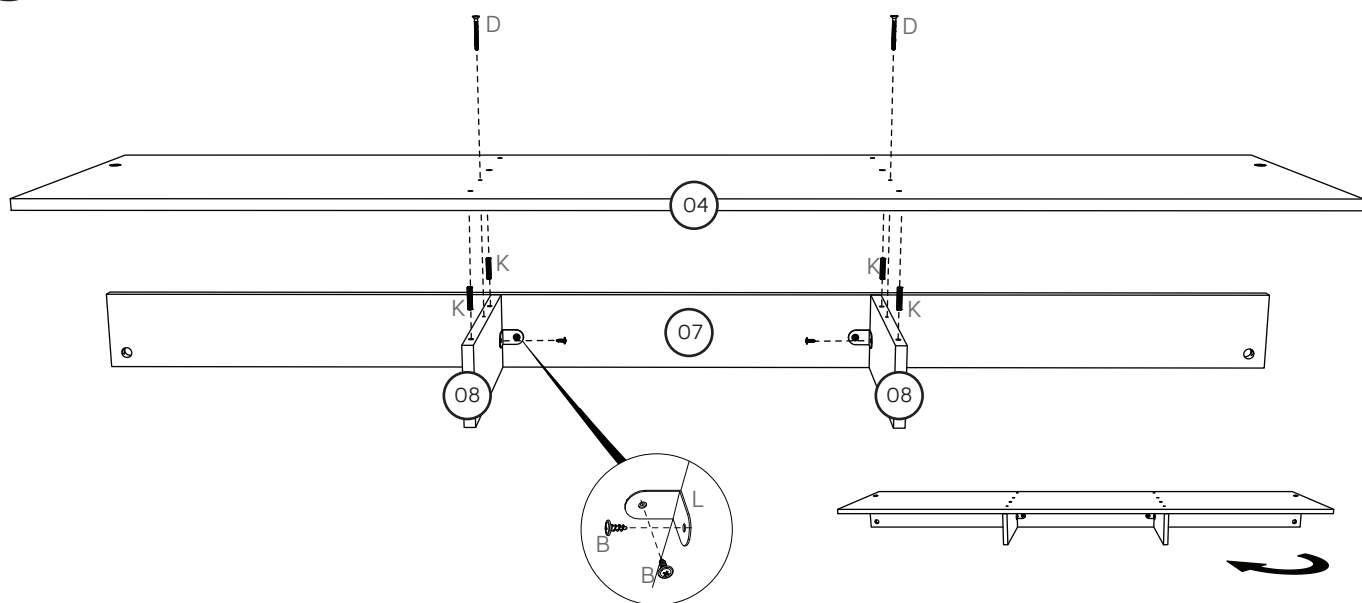





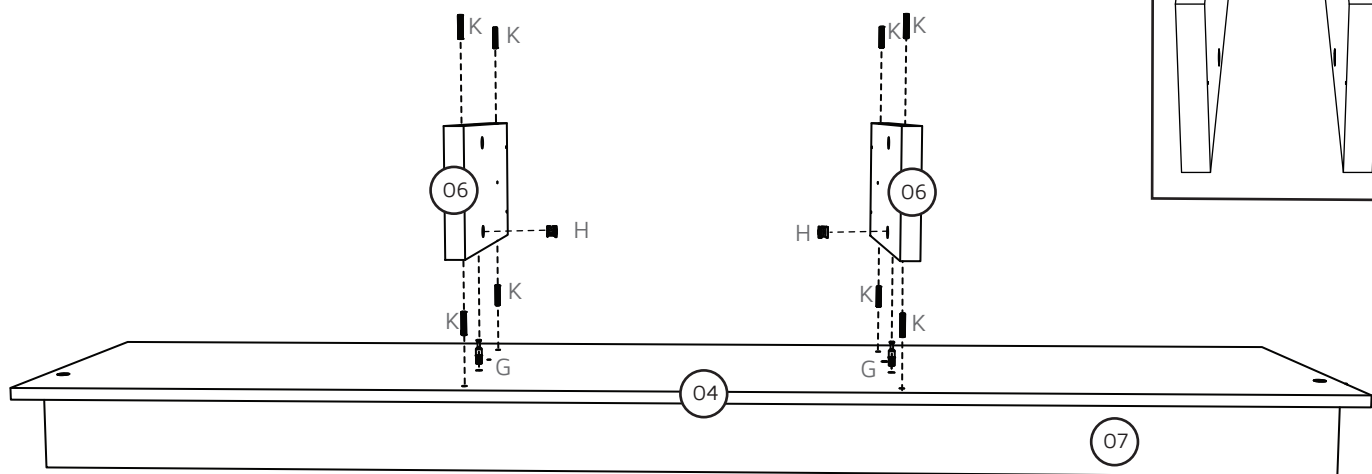
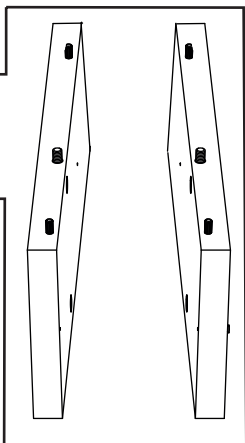

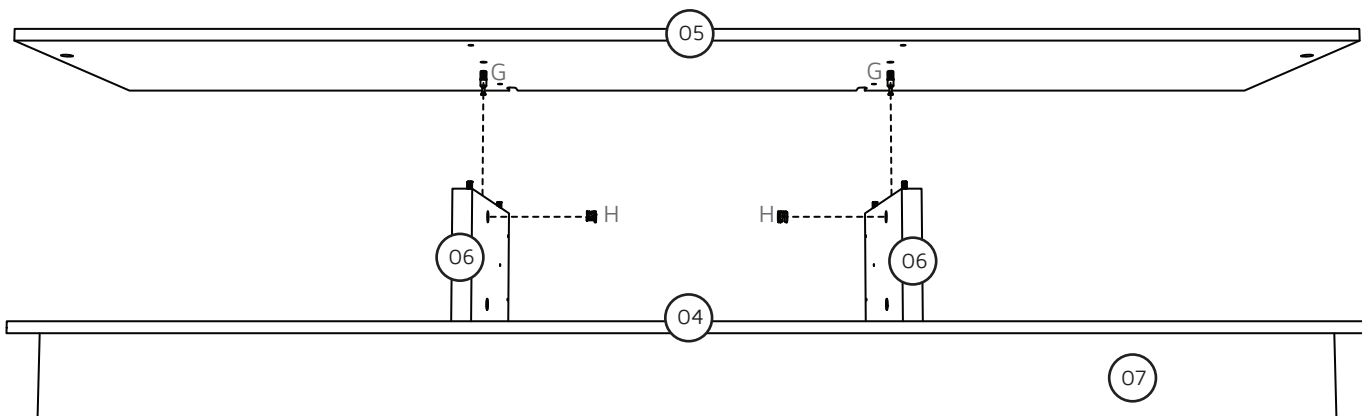

02

Attention
The holes on parts are placed inwards the parts.

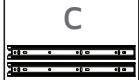

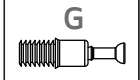
03

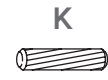

COD. 1533 A 	COD. 2661 C 	COD. 8056 E 	COD. 9895 G 	COD. 10063 H 	COD. 10342 J 	COD. 1668 K 	COD. 10499 P 
---	---	---	---	--	--	---	--

04

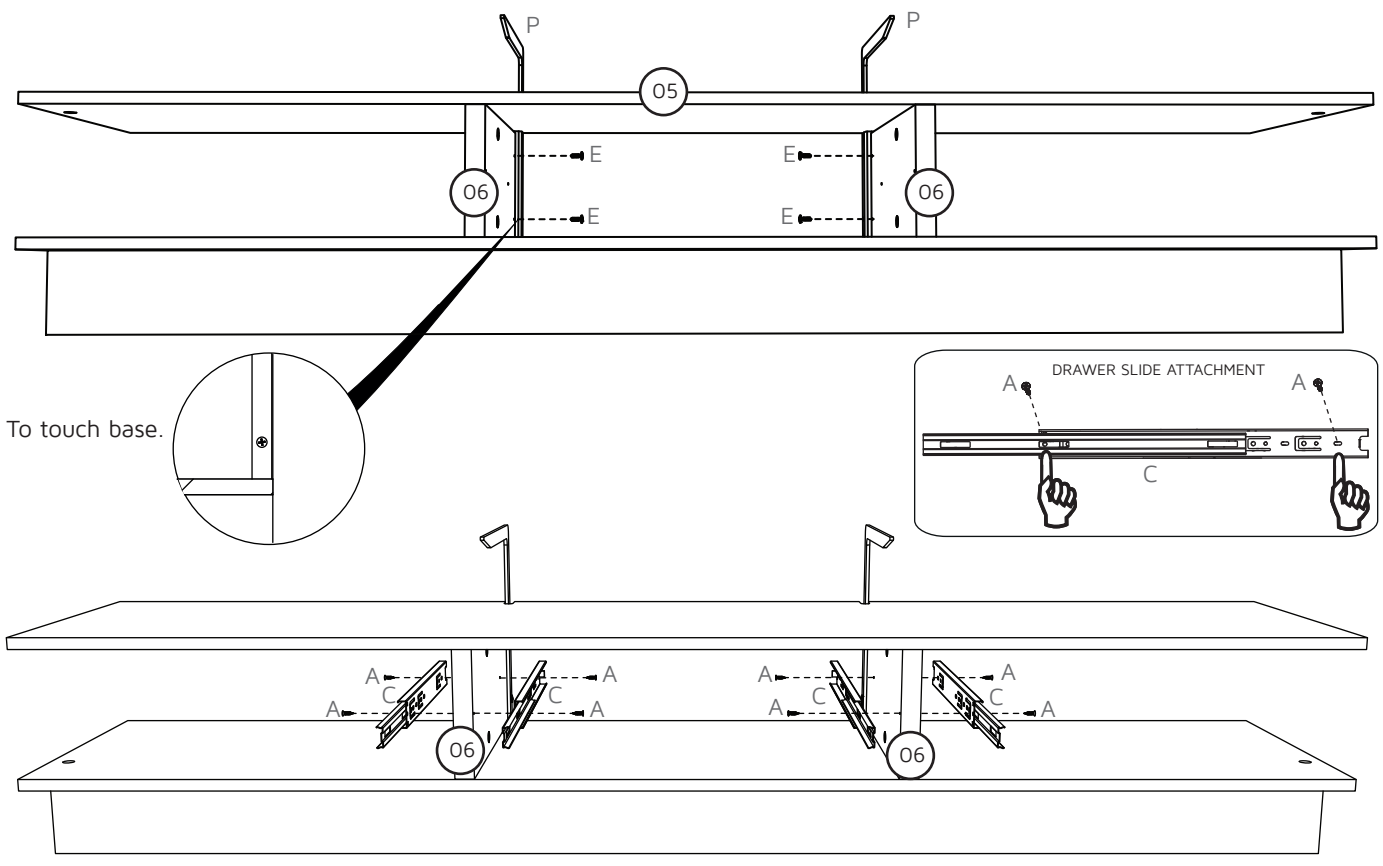

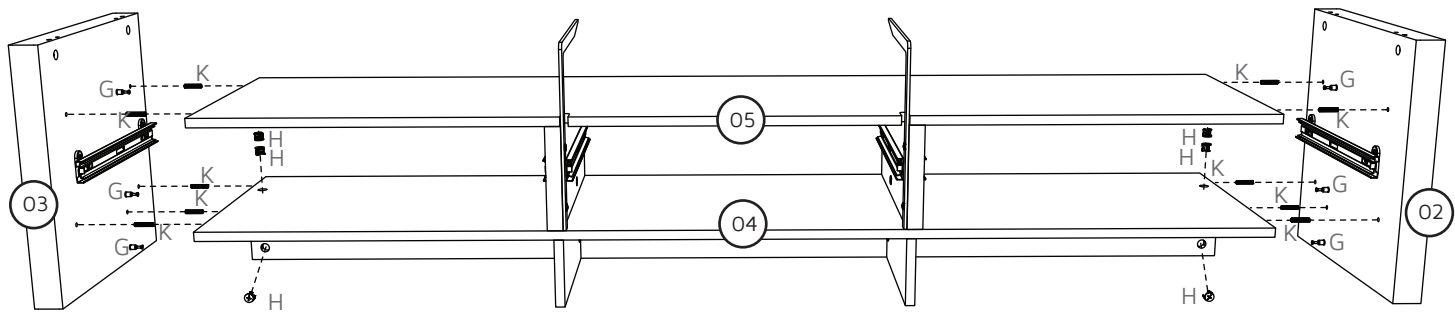
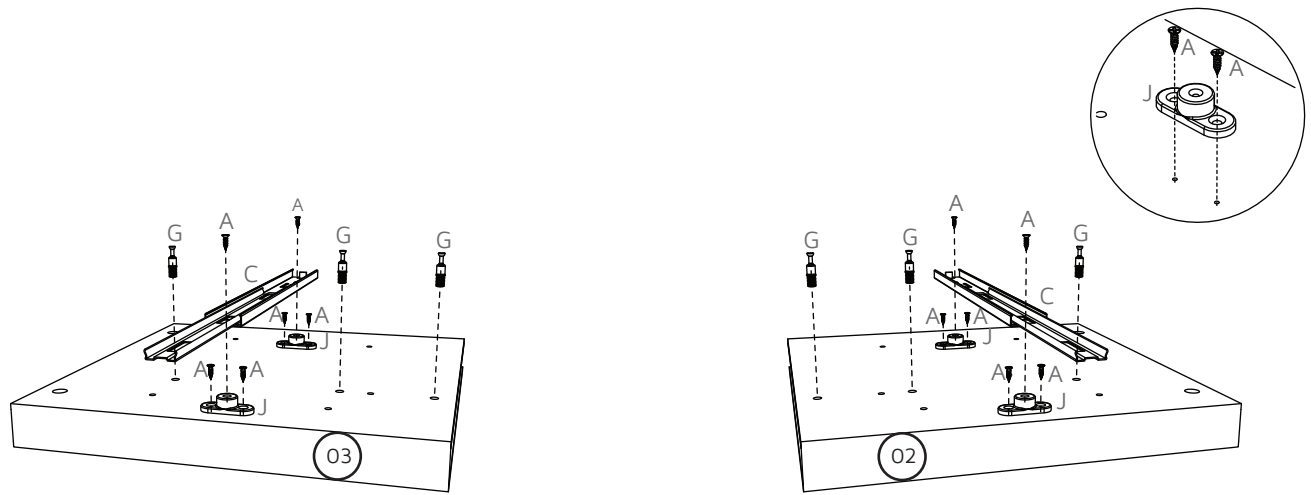

05



06





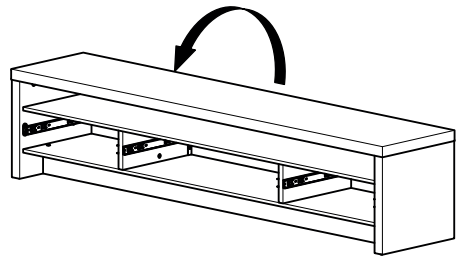
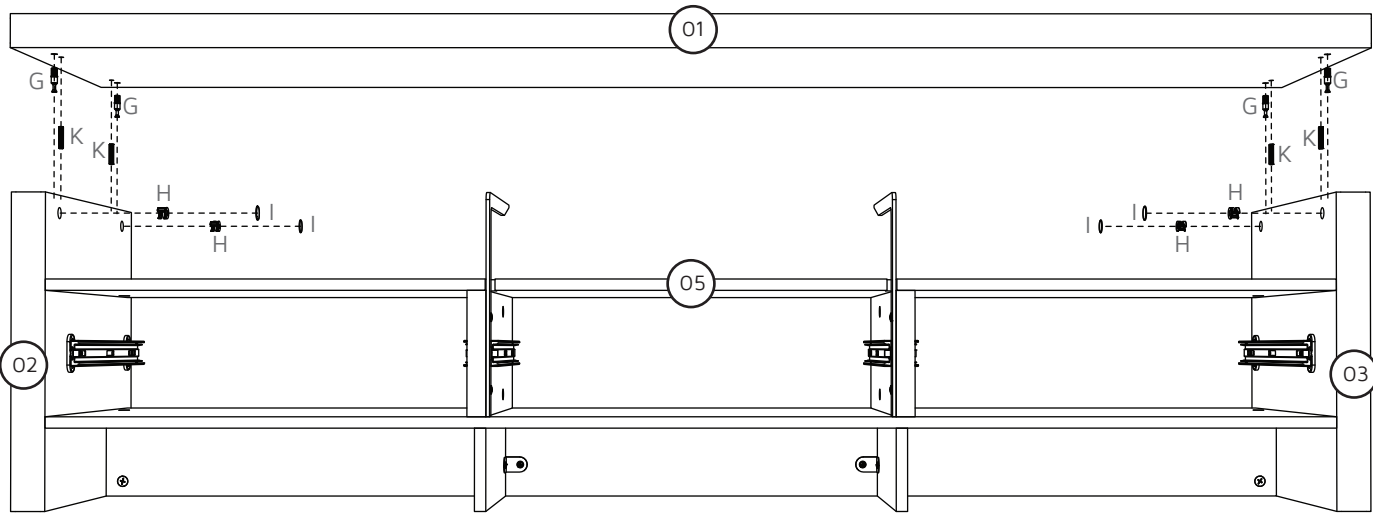

06

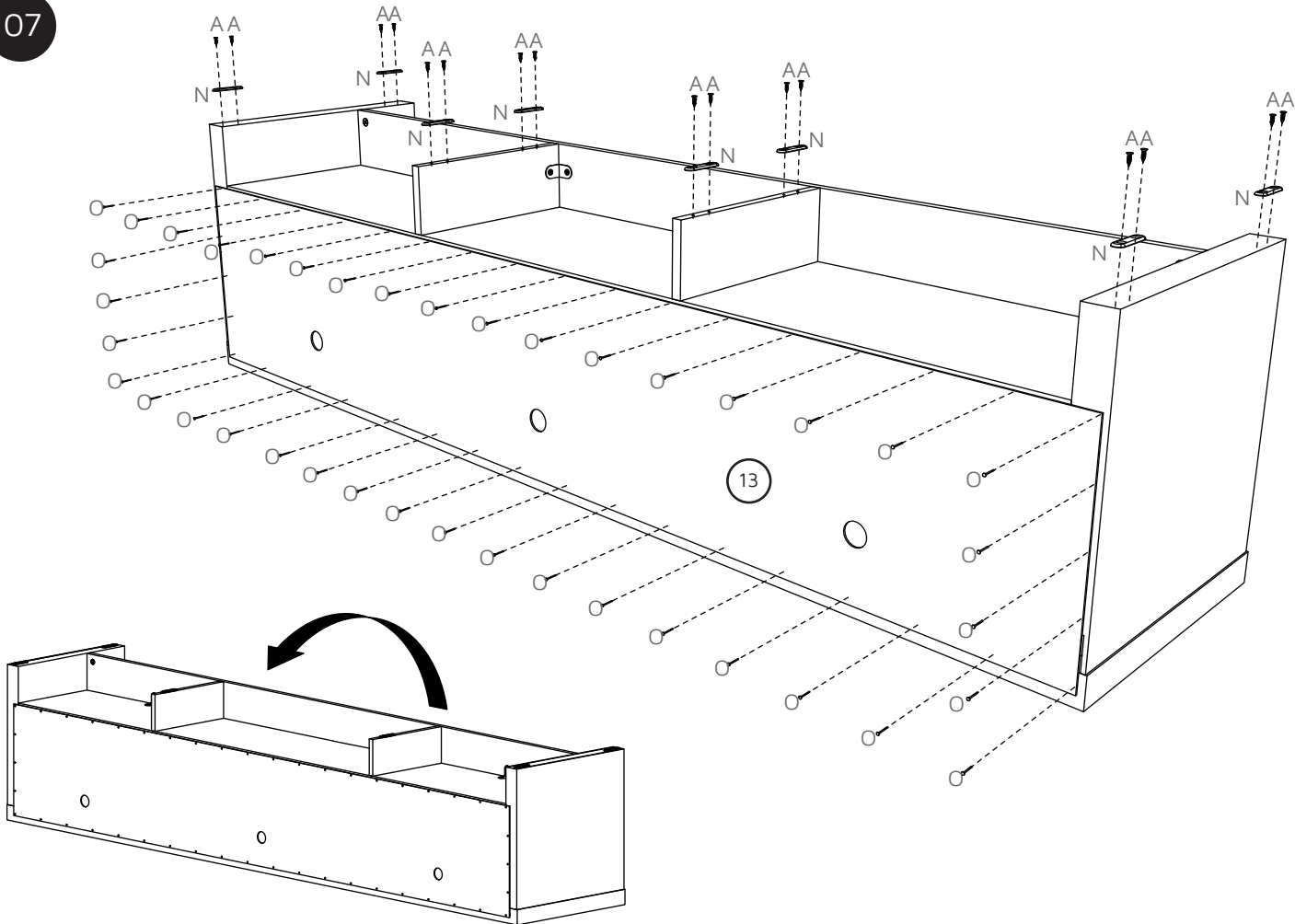
cod. 1533 A 	cod. 9895 G 	cod. 10063 H 	STICKER I 	cod. 1668 K 	cod. 0136 N 	cod. 0357 O 
---	---	--	--	---	---	---



07



COD. 1533 A 	COD. 2661 C 	COD. 3527 D 	COD. 6533 F 	COD. 1668 K 	COD. 0338 M 
---	---	--	---	---	---

08

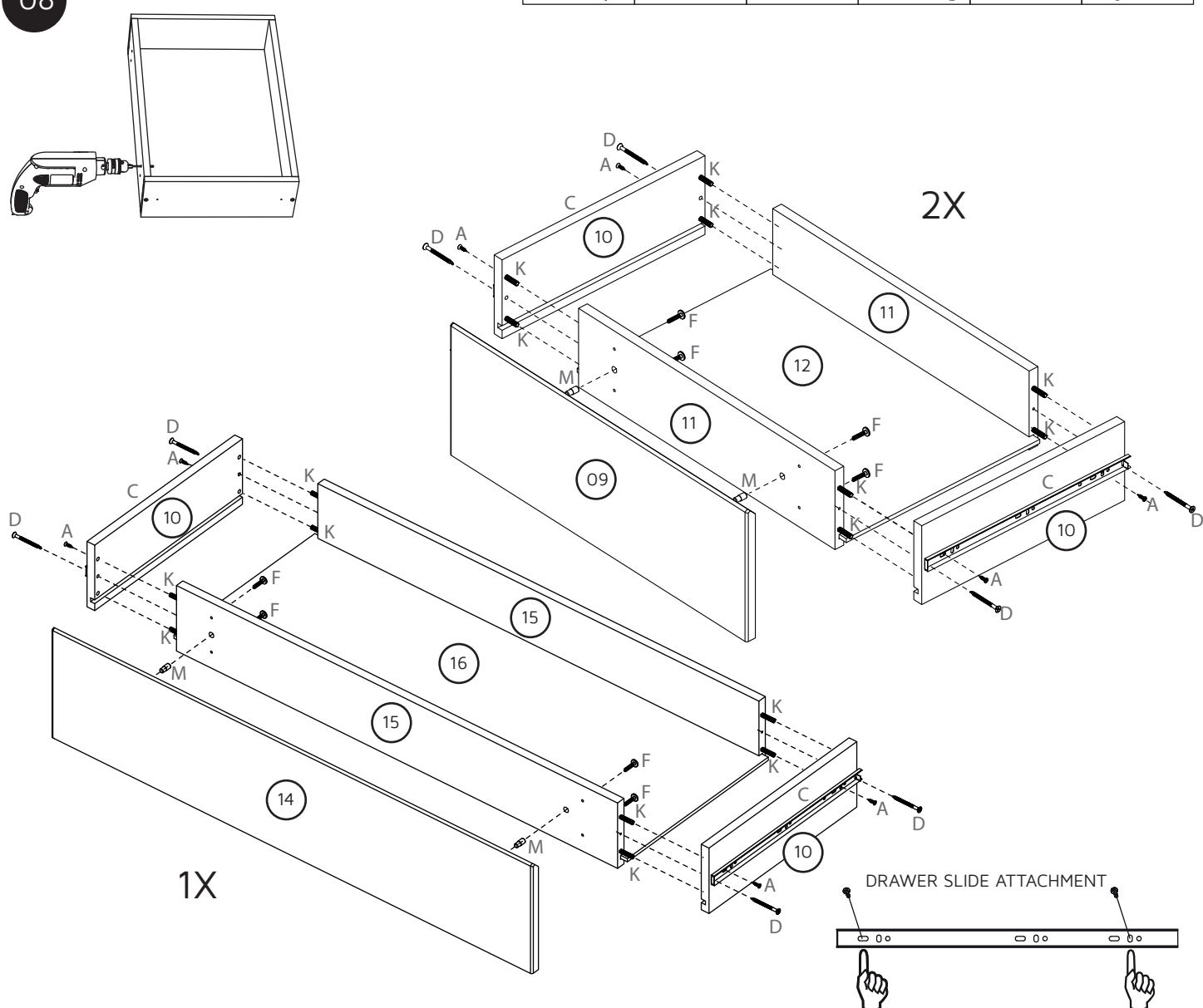

09

