

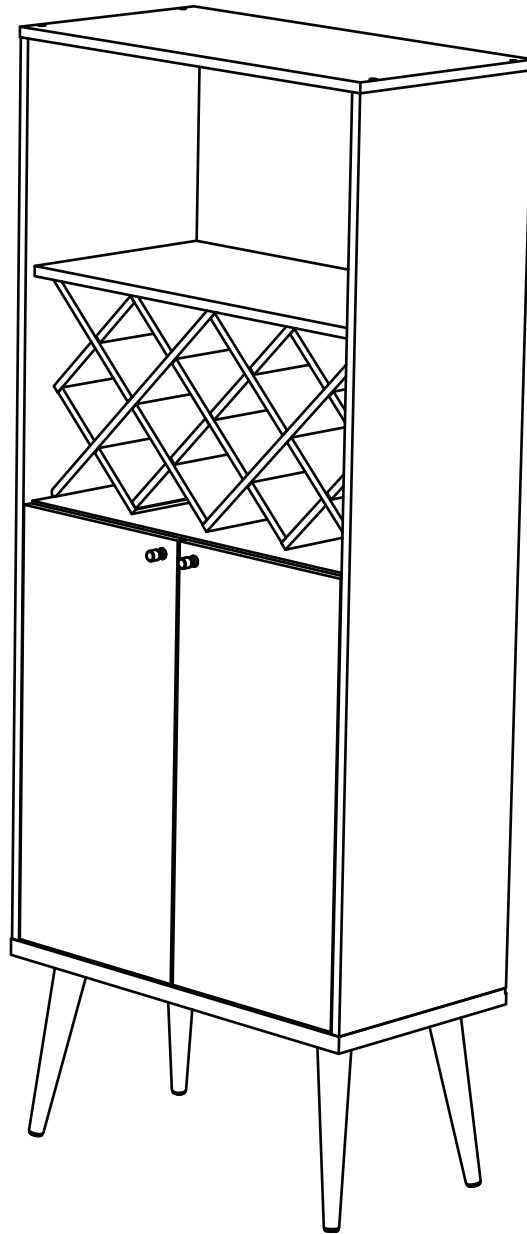

MANHATTAN
COMFORT

ASSEMBLY INSTRUCTIONS



COD: 89900

IMPORTANT REMARKS



Never climb or lean on the furniture.
You may suffer serious accidents.

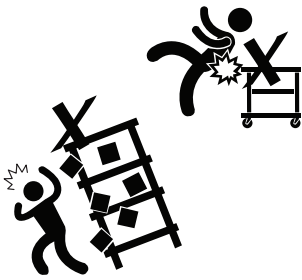

Use the packaging to cover the
assembly area and separate
all parts.

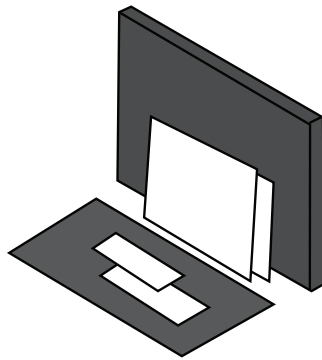

Identify the parts by observing the
number printed on their edges.

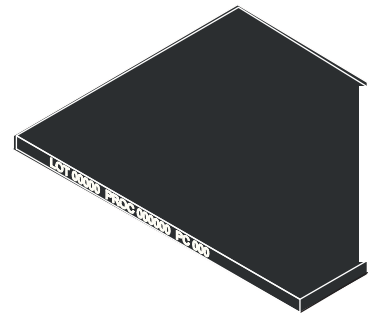

CARE INSTRUCTIONS



Wipe clean using a damp cloth and a mild cleaner.
Do not use abrasive and chemical products.



HANDLING

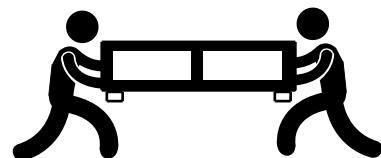

Move the piece carefully, don't drag it. Ask
for someone else's help to do so.

HARDWARE



Identify and separate the hardware used in the assembly. There's a label on each package identifying the parts and where to use them.

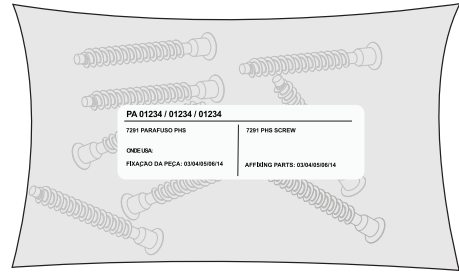

COD. 2088-1x



A

COD. 9425-4x

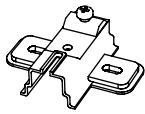

B

COD. 3934-1x

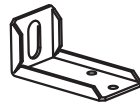

C

COD. 5681-1x

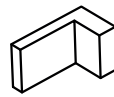

D

COD. 9328-2x

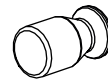

E

COD. 0494-4x



F

COD. 1668-36x



G

COD. 8471-4x

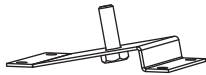

H

COD. 0342-18x



I

COD. 8240-1x



J

COD. 7292-1x



K

COD. 8903-4x

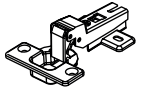

L

COD. 7291-8x



M

COD. 0599-4x



N

COD. 7499-50x

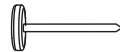

O

COD. 0502-3x



P

COD. 3527-8x

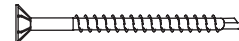

Q

COD. 7519-16x



R

COD. 8056-16x



S

COD. 0357-18x



T

COD. 6244-1x



U

COD. 3187-2x



V

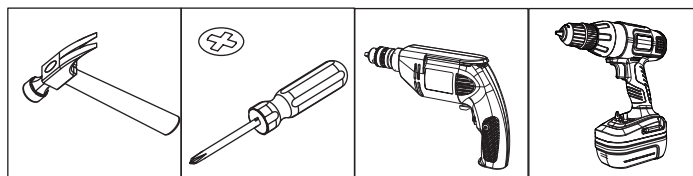







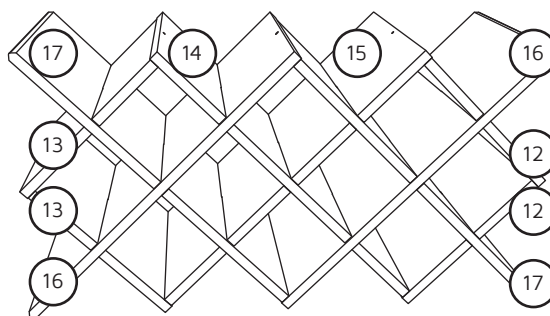
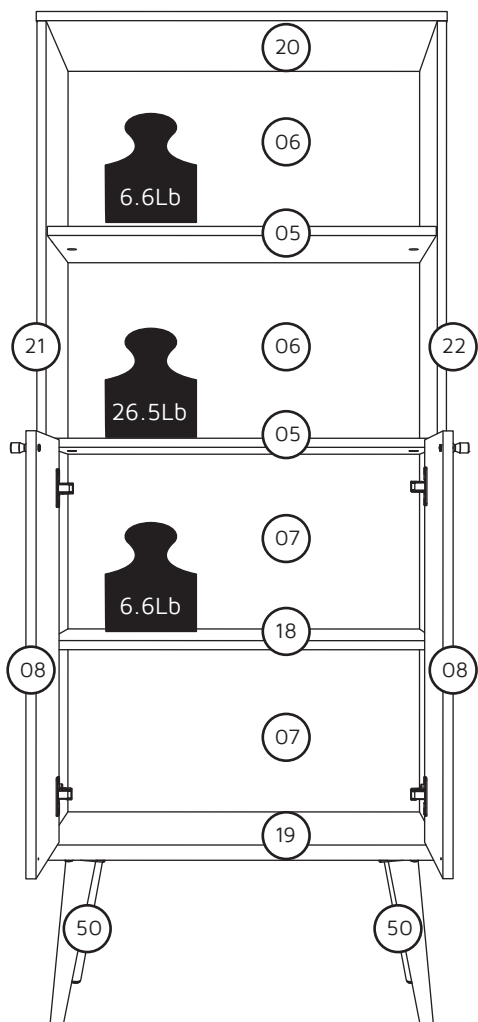
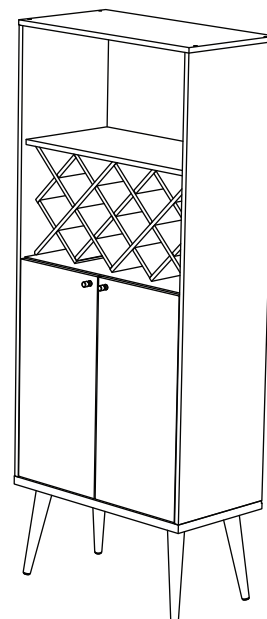

DESCRIÇÃO DESCRIPTION DESCRIPCIÓN

CÓD:89900			
PART	QUANTITY	DESCRIPTION	BOX
05	2	SHELF	01
06	2	UPPER BACKPLATE	01
07	2	BOTTOM BACKPLATE	01
08	2	DOOR	01
12	2	SHORT RIGTH SIDE	02
13	2	SHORT LEFT SIDE	02
14	1	RIGHT CENTRAL PART	02
15	1	LEFT CENTRAL PART	02
16	2	LEFT SIDE	02
17	2	RIGTH SIDE	02
18	1	SHELF	01
19	1	BASE	01
20	1	TOP BOARD	01
21	1	LEFT SIDE	01
22	1	RIGTH SIDE	01
50	4	LEG	02

W: 26.50in H: 65.75in D: 13.98in
L: 673mm A: 1670mm P: 355mm

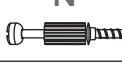

COD. 9425 B 	COD. 9328 E 	COD. 0494 F 	COD. 1668 G 	COD. 7292 K 	COD. 8903 L 	COD. 7291 M 	COD. 0599 N 	COD. 7519 R 	COD. 3187 V 
---	---	---	---	---	---	--	---	---	---

01

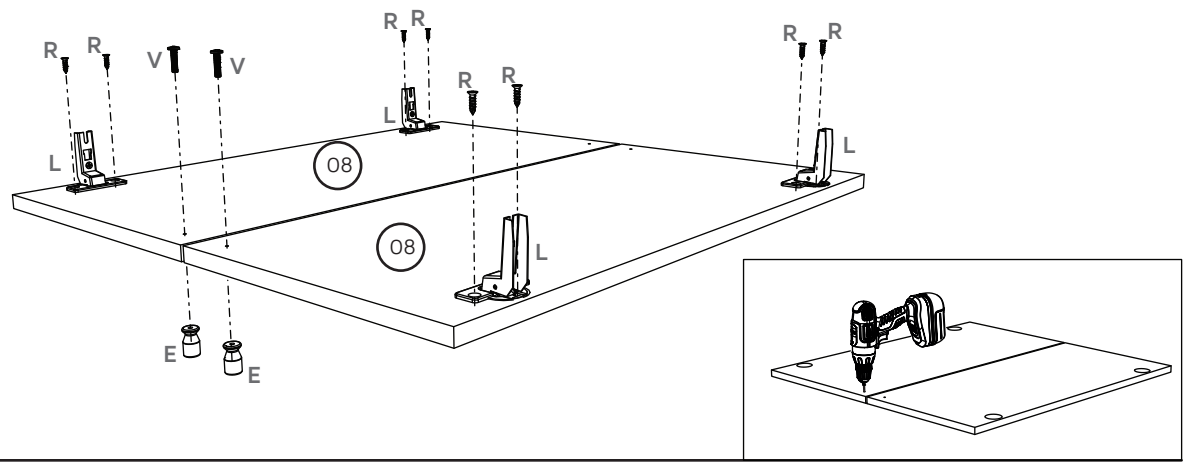

02

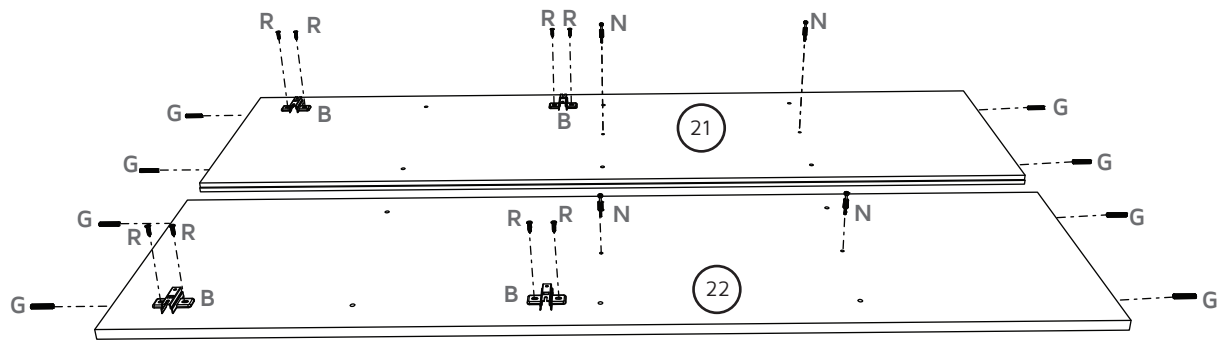



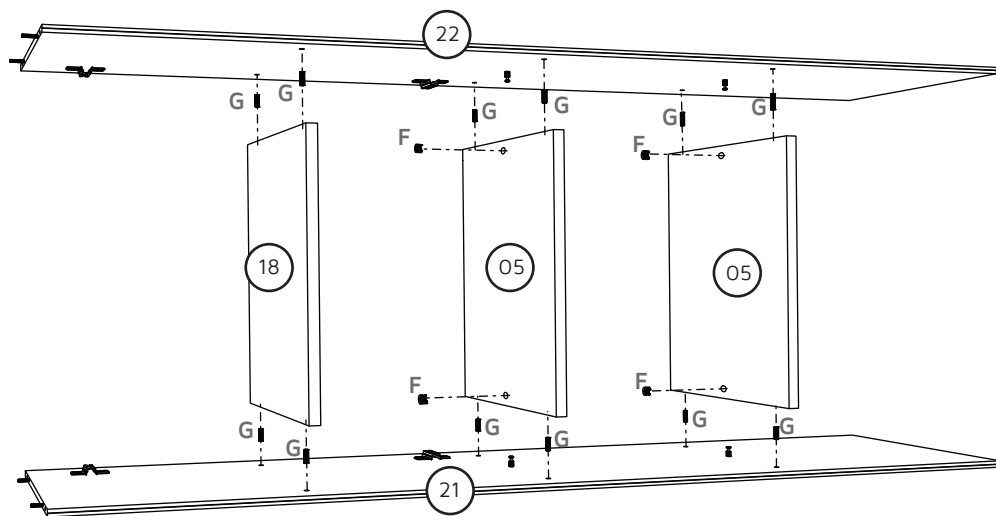

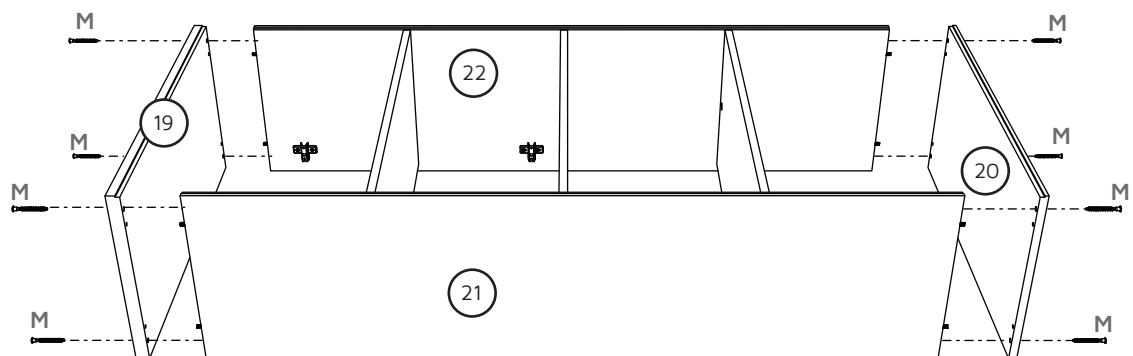
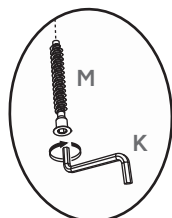

03

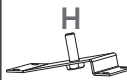

04



COD. 8471 H 	COD. 0342 I 	COD. 8240 J 	COD. 7499 O 	COD. 8056 S 	COD. 0357 T 
--	--	---	--	--	--

05

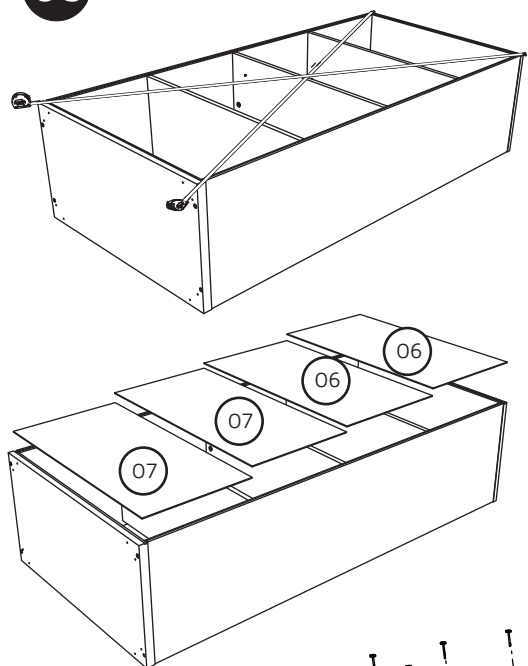



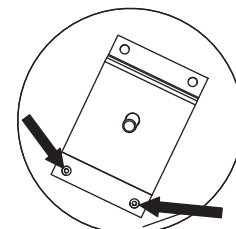
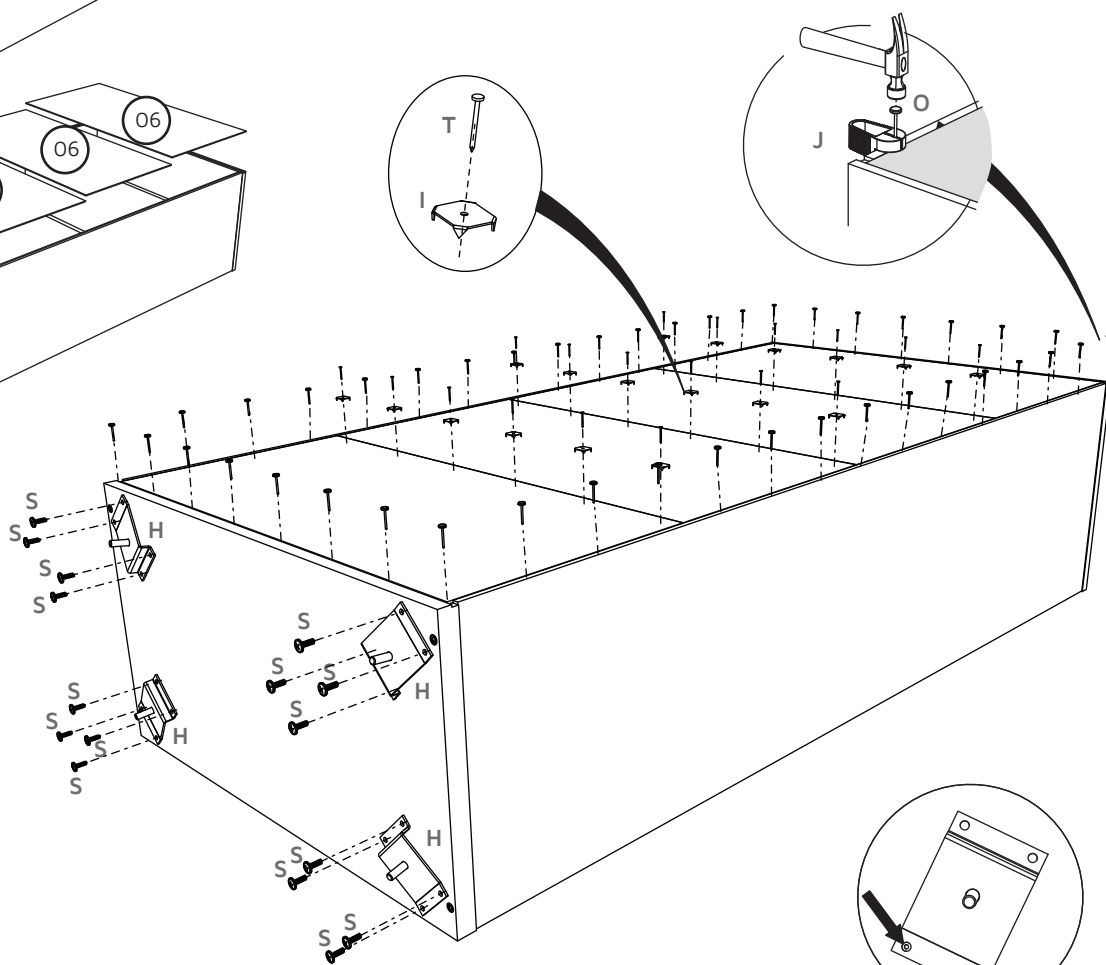



Before nailing the backplate, set it square to avoid alignment problems in the assembly.

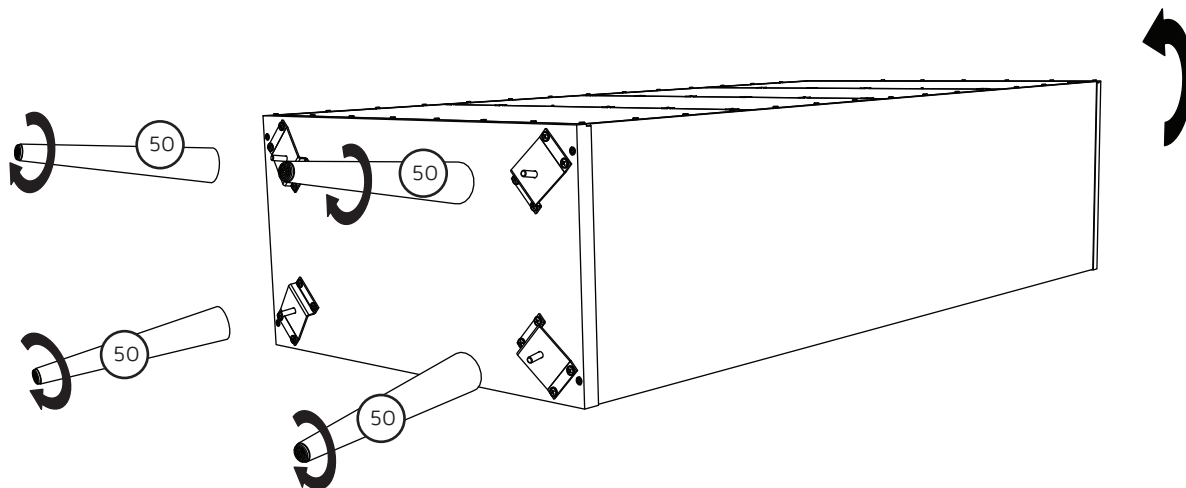

Place them using pilot hole.

06



COD. 2088 A 	COD. 3934 C 	COD. 5681 D 	COD. 1668 G 	COD. 0502 P 	COD. 6244 U 
---	---	---	---	---	---

07

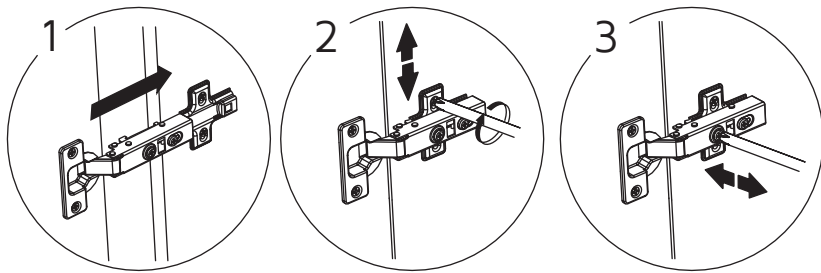
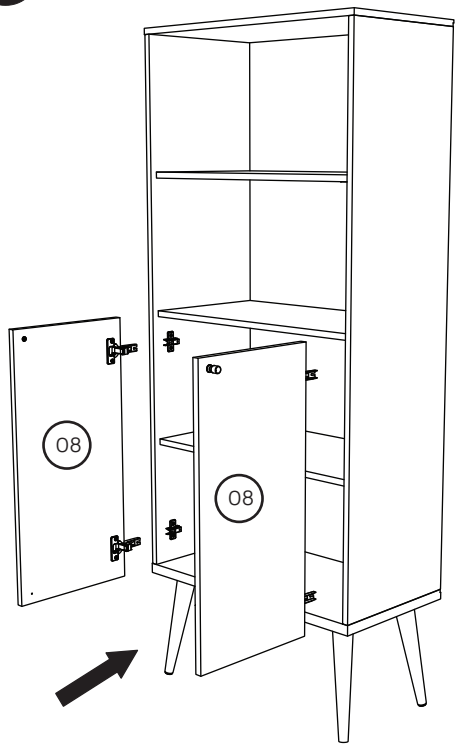

08

It's mandatory to fix this safety device.

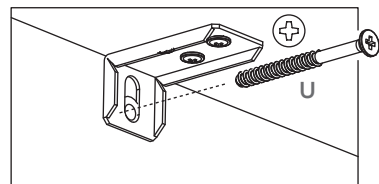
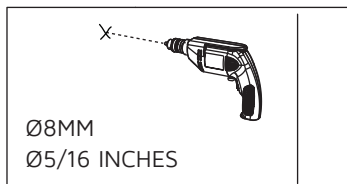
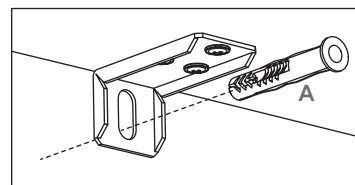
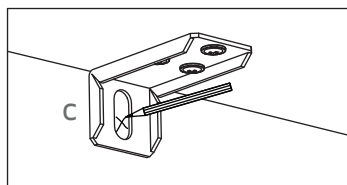
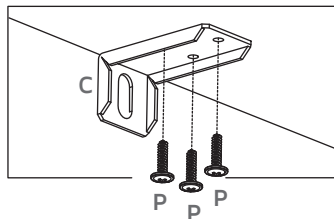
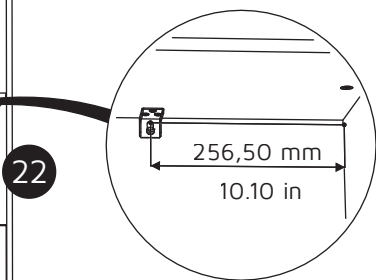
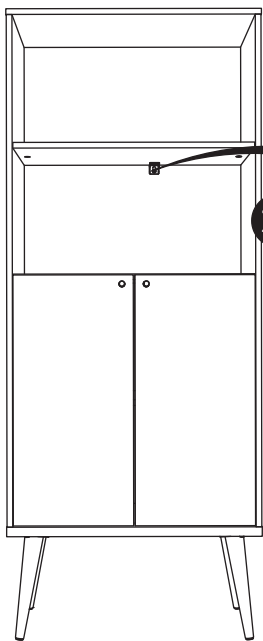

09

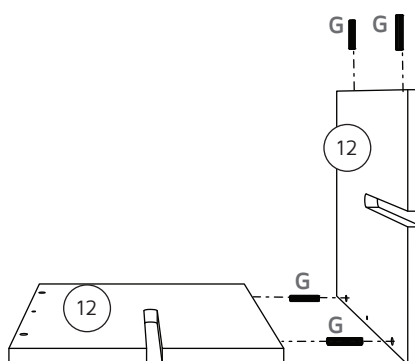
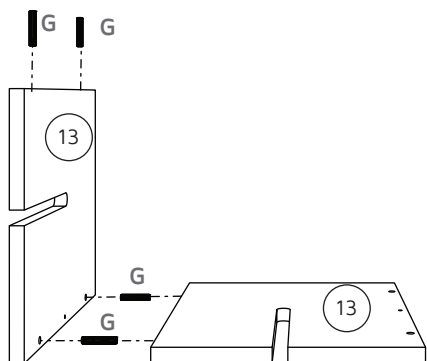

10

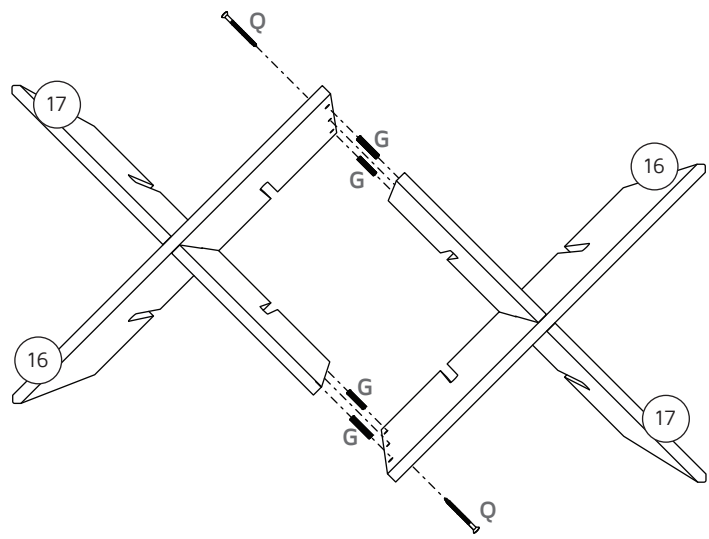

11

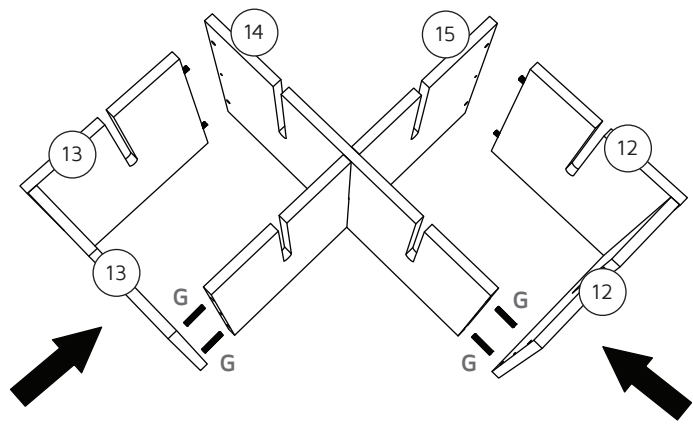

12

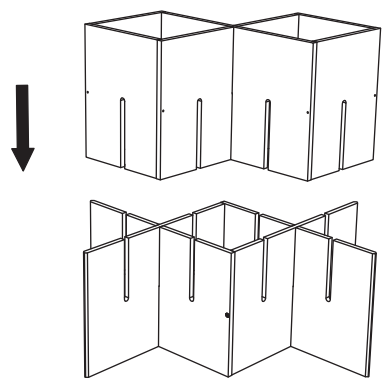

13

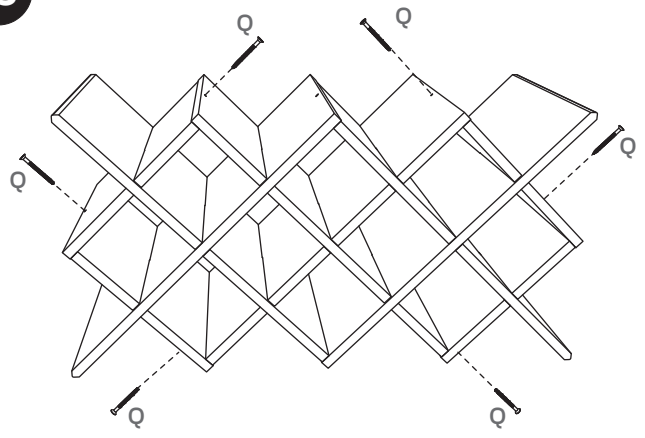

14

